

MyPropTech

Nick Yan  
+ 852 9064 8554  
n.yan@myproptech.com  
www.myproptech.com



**CORONATION  
SQUARE**  
LEYTON



**Taylor  
Wimpey**



Computer generated image.



# Welcome to Coronation Square

**A PLACE WITH HEART.  
A HOME TO LOVE.**

New 1, 2 & 3 bedroom apartments in the heart of Leyton. Set around a Central Square with amenities from shops to sports and health facilities, these homes are perfect for first time buyers, families, professionals and those looking for a balanced city lifestyle.



# 03



# CORONATION SQUARE

LEYTON



05



## From the bustling high street to a green oasis

### Enjoy all that Leyton has to offer

Much sought after by those who love its combination of character and sense of community, Leyton has deep roots and a distinctive identity. With its great connections to central London and the City, together with an excellent choice of cafés, relaxing pubs, local shops and gardens, Coronation Square is ideal for modern living.



# A breath of fresh air



^ CORONATION GARDENS

There is a strong beat to Leyton's urban pulse, and yet a wealth of open spaces that will draw you outdoors all year round. The buzzing plaza at Coronation Square for instance, brings a continental feel, enhancing the connections to Leyton's beautiful Coronation Park, while the wonderful local parklands and waterways are perfect to visit all year round. From special bird havens to the hundreds of acres of Queen Elizabeth Olympic Park, there is room for everyone.



^ MIDDLESEX FILTER BEDS



^ WALTHAMSTOW WETLANDS

Coronation Gardens has been Leyton's civic park for over a century. Here you can enjoy the lawns and colourful summer borders, explore the maze near the rose garden, or find shade under one of the many mature trees. Its original bandstand now hosts performances by local musicians across a range of genres. Leyton's Saturday food market gathers around it too, with stalls selling fresh-baked bread, brioche rolls and bagels, artisan coffee, and some of the capital's favourite street food from around the world.



LEYTON  
STATION

LONDON CITY  
AIRPORT

STRATFORD

QUEEN ELIZABETH  
OLYMPIC PARK

LEYTON  
ORIENT FC

CORONATION  
GARDENS

CANARY  
WHARF

HACKNEY  
MARSHES

SALES  
OFFICE

  
CORONATION  
SQUARE  
LEYTON

Aerial view with computer generated image of Coronation Square. The development layout does not show details of gradients of land, boundary treatments, local authority street lighting or landscaping. It is our intention to build in accordance with this layout. However, there may be occasions when the property designs, boundaries, landscaping and positions of roads and footpaths change as the development proceeds. Please check the details of your chosen property with a sales executive prior to reservation.



# London calling

**MAKING IT EASIER TO BE WHERE YOU WANT TO BE.**

With some of the world's best sights, attractions and activities easily in reach, Coronation Square is perfect for commuting or visiting the capital.

Leyton underground station is a short walk away with Central line services into Stratford taking just two minutes. DLR connections here lead to Canary Wharf, while Central line connections head to London Liverpool Street and the West End.

## BY TUBE FROM LEYTON STATION – ZONE 3

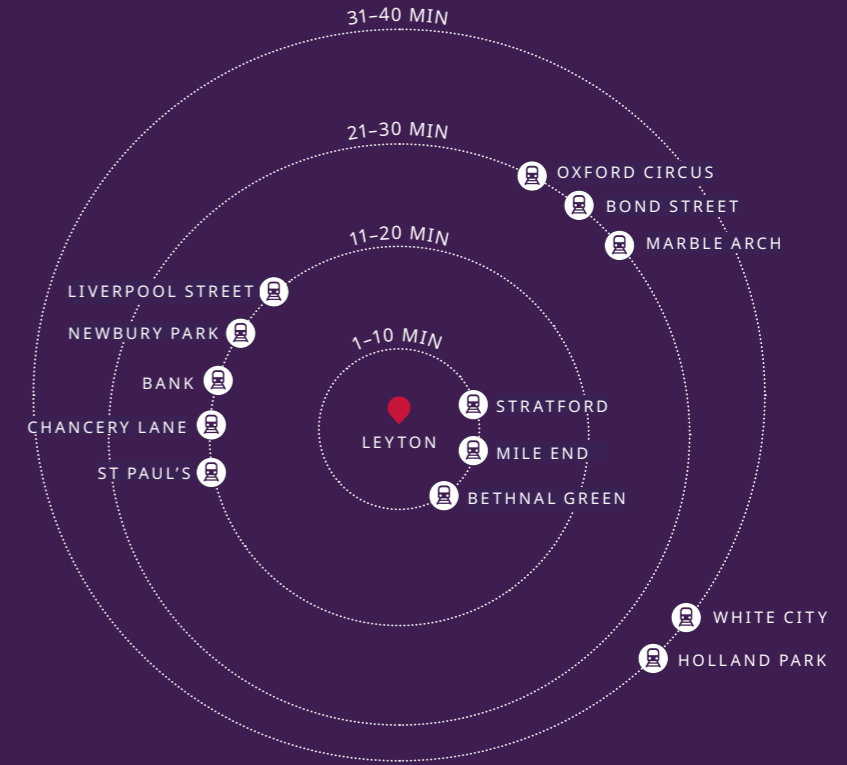

## ON FOOT AND BICYCLE FROM CORONATION SQUARE

CORONATION SQUARE LEYTON		
4 MIN	Leyton High Road	1 MIN
9 MIN	Leyton Jubilee Park	3 MIN
11 MIN	Leyton Station	4 MIN
11 MIN	Queen Elizabeth Olympic Park	4 MIN
13 MIN	Leyton Cricket Ground	5 MIN
17 MIN	Leyton Midland Road Station	5 MIN
19 MIN	Hackney Marshes	8 MIN
22 MIN	Leyton Leisure Centre	7 MIN
26 MIN	Leytonstone High Road Station	8 MIN
27 MIN	Westfield Stratford City	10 MIN
28 MIN	Lea Bridge Station	8 MIN
36 MIN	Stratford Station	11 MIN

Travel times taken from google.co.uk/maps, tfl.gov.uk and nationalrail.co.uk and are approximate only.

# 13

Invested in a  
bright future



# A place alive with people and possibilities

Coronation Square is 21st century London. Fountains of water bounce with light and energy in an exciting development that is bringing new jobs and investment, and encouraging existing businesses. It is a place alive with people enjoying a setting made for everyday life and for the special events that bring people together.



Computer generated image.



Computer generated image.

## THE CIVIC SQUARE – SOCIAL AND SUSTAINABLE

The new public square is a focus for Coronation Square and all Leyton residents. It's the place to visit the outdoor market as well as the new market hall and enjoy the superb new amenities that line the square, or if you like, to simply sit and take in the surroundings.

## PLAY AREAS TO ENGAGE YOUNG MINDS AND BODIES

The open spaces at Coronation Square have dedicated play places that children will love, from natural lawns to equipment designed for imaginative play. There is also outdoor table tennis, and a water feature to bring a big splash of extra fun.

## HIGH QUALITY LANDSCAPING – PEOPLE, PLANTS AND PUBLIC OPEN SPACE

Coronation Square has been designed by those with a talent and a passion for landscaping and there's a rich biodiversity in the shrubs, wildflowers and habitats landscaped into the development. Nowhere can it be more appreciated than when sitting or engaging with friends at the communal benches and tables.



Computer generated image.

## NHS HEALTH HUB AND PHARMACY

A modern, purpose-built health centre for the Coronation Square neighbourhood with handy pharmacy providing treatment and consultation for all registered residents.



## PRE-SCHOOL NURSERY AND PRIVATE PLAY AREA

This purpose-built nursery on the Square is in a car-free zone to make drop-off and collection safer. There will be plenty of buggy parking for mums or dads while the children enjoy fresh-air play in the nursery's own private outdoor area.

## SPORTS CENTRE

With a ground-floor café opening onto the Square, the Sports Centre is equipped with first-floor studios for exercise and dance classes, and multi-purpose courts for badminton, basketball, five-a-side and gymnastics. This is the perfect place for future Olympic champions to develop their skills.



# Choose a home that suits you

Designed from the start to complement its surroundings in every way, Coronation Square brings its own contemporary style and feel to Leyton. Using London Brick, an icon of the capital's streets, Coronation Square's red brick façades are contrasted with white bricks for a fresh new look.

Inside each home, whether you choose a 1, 2 or 3 bedroom apartment, you'll find thoughtfully designed living space. Over half of the homes at Coronation Square have open views with dual-aspect rooms inviting the sunlight in.

You can also relax on your own balcony or terrace looking out across garden courtyards at ground or podium level.



Photography of Coronation Square show apartment.



Photography of Coronation Square show apartment.



Photography of Coronation Square show apartment.



# CORONATION SQUARE

LEYTON

## SPECIFICATION

The specification at Coronation Square gives you a unique opportunity to select which colour palette you prefer for your kitchen and bathroom. Choose from between the light and dark palettes and put your own stamp on your new home.

The information below shows the intended specification for each of the homes available at Coronation Square. Everything has been professionally designed and thoughtfully chosen to maximise space and light.

### KITCHEN

- Nobilia fitted kitchen units, laminate worktop and full-height splashback
- Integrated appliances
  - Siemens stainless steel built-under single oven or double oven built in tall housing
  - Siemens induction hob
  - Integrated extractor hood
- Zanussi Fridge/Freezer
- Zanussi Dishwasher
- Zanussi Washer/Dryer\*
- Soft close doors/drawers
- Under wall unit lighting
- Handle lighting
- Franke composite sink with 1.5 bowl in black or grey and Franke tap

### BATHROOMS

- White sanitaryware throughout with 180 litre bath
- Satin chrome mixer tap to wash hand basins
- Thermostatic shower, bath screen and full-height tiling to bath
- Half-height tiling to all walls
- Thermostatic shower and full-height tiling to shower enclosure in en suite
- Wall mirror included to main bathroom
- Tiled flooring
- Extractor fan
- Shaver socket to en suite or main bathroom (if no en suite)
- Satin chrome heated towel rail to bathroom and en suite

### DOORS AND WINDOWS

- Timber front entrance door with multi-point lock
- Aluminium double glazed windows with security locks
- Video door entry system

### ELECTRICAL

- Satin chrome downlighters to kitchen/living area, bathrooms, en suites and cloakrooms
- Energy-efficient pendant ceiling lights to all other rooms
- USB charge point to kitchen double socket\*\*
- Satin chrome switches throughout
- Multi-socket media plate to living room (specific provider to be connected by purchaser)
- TV and telephone point to bedroom 1 (specific provider to be connected by purchaser)
- Mains operated smoke detector with battery backup
- Mechanical extract ventilation to selected plots†
- Balcony downlight

### HEATING

- Central district heating system - no gas to individual dwellings
- Underfloor heating throughout with the exception to bathrooms, cloakrooms and en suites

### INTERNAL FINISHES

- White painted internal doors with chrome furniture
- Soft white painted walls and smooth white ceilings
- White painted mouldings including skirting boards, architraves and window boards

### FLOORING

- Abingdon essential carpet to bedrooms
- Amtico Spacia to all other areas, (with the exception to bedrooms and bathrooms)

### WARDROBES

- 1300mm wardrobe with glazed sliding doors to bedroom 1 (location as shown in brochure)††
- Top shelf and hanging rail included



Photography of Coronation Square show apartment.



Photography of Coronation Square show apartment.

NB Flow restrictors included to reduce water consumption. Standard specifications are correct at time of broadcast, but are subject to change without notice. Please contact the sales executive for further information. \*Located within hall cupboard to certain plots. Please speak to a sales executive for further information. \*\*Standard sitting, no surge protection. †Please refer to the sales executive for specific details. ††Size is approximate, variations do occur due to layout restrictions. These are the only options available and are subject to stage of construction. We will not be able to accommodate any changes to the specification or layout other than the options available. Options are correct at time of broadcast, but are subject to plot size. Please speak to a sales executive for further details. Images are of the light specification and are of the light colour palette. Image may include optional upgrades at additional cost. January 2023.

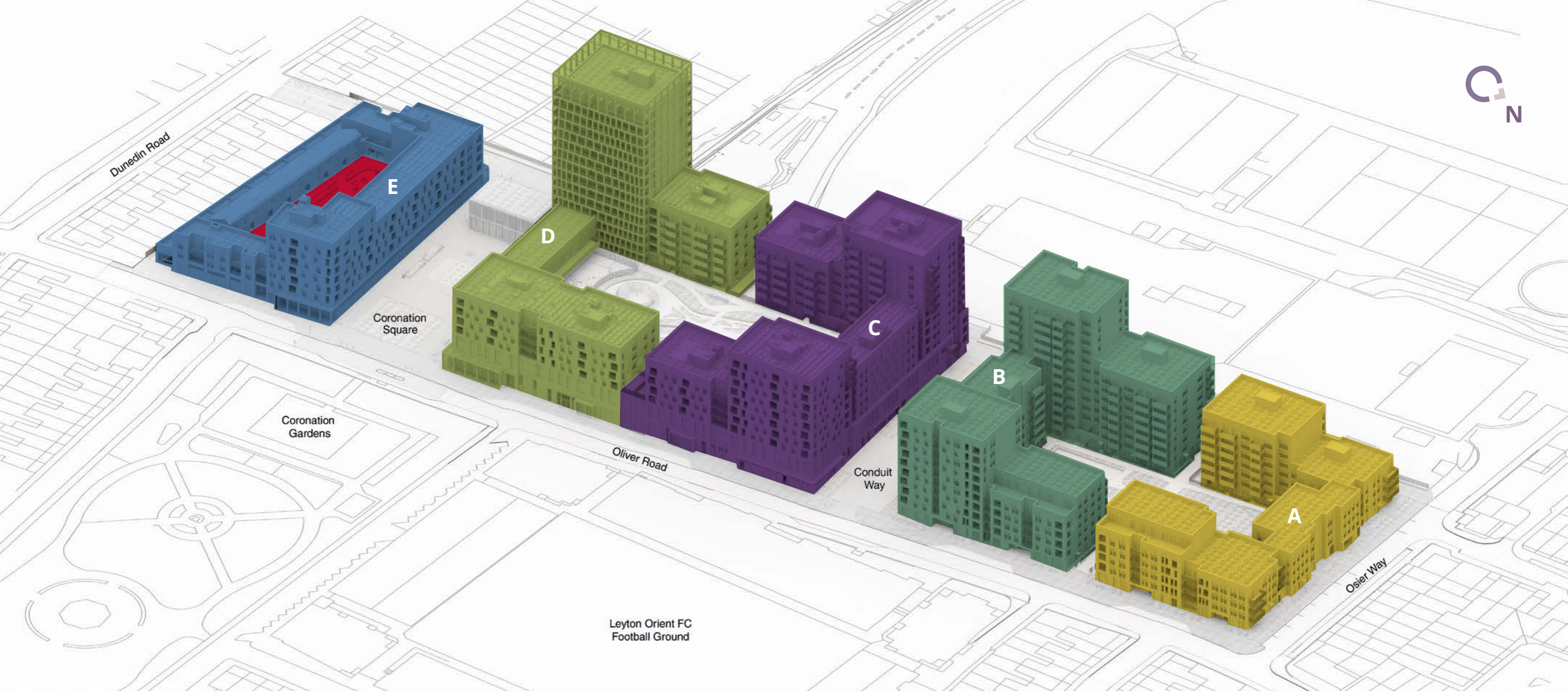

# Development layout

**MORE THAN A VISION FOR LEYTON,  
A PLACE DESIGNED FOR LIFE.**

With its rich choice of apartments, each home at Coronation Square combines contemporary design with beautiful living space and looks out onto an exciting architectural neighbourhood designed to harmonise with the local surroundings.

## PHASE 1

- Block C  
Plots 410–429
- Block D  
Plots 68–205
- Block E  
Plots 1–67
- Communal gardens and play area

## PHASE 2

- Block A  
Plots 660, 665 & 722–735
- Block B  
Plots 457–641

This development layout does not show details of gradients of land, boundary treatments, local authority street lighting or landscaping. It is our intention to build in accordance with this layout. However, there may be occasions when the property designs, boundaries, landscaping and positions of roads and footpaths change as the development proceeds. Please check the details of your chosen property with your sales executive prior to reservation.

BLOCK D

# Ground Floor

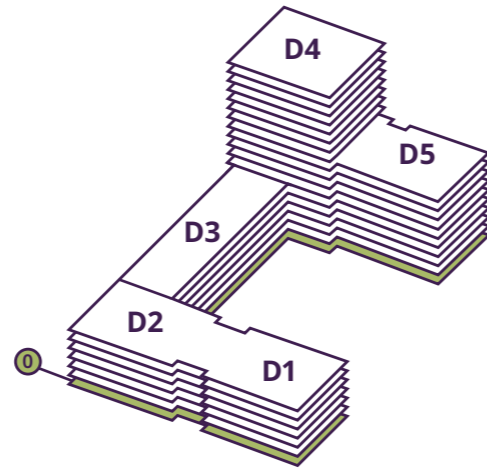

## We build for the future

A ground-floor café will open onto the square, and will include the NHS Health Hub, a sports centre and a children's nursery.

The residents' concierge and lounge makes Coronation Square the perfect place to call home. Within Block D3, the sports centre is located on the ground, first and second floors with the children's nursery located on floors three to five.



- Resident's Space
- Non Resident's Space
- Commercial Space

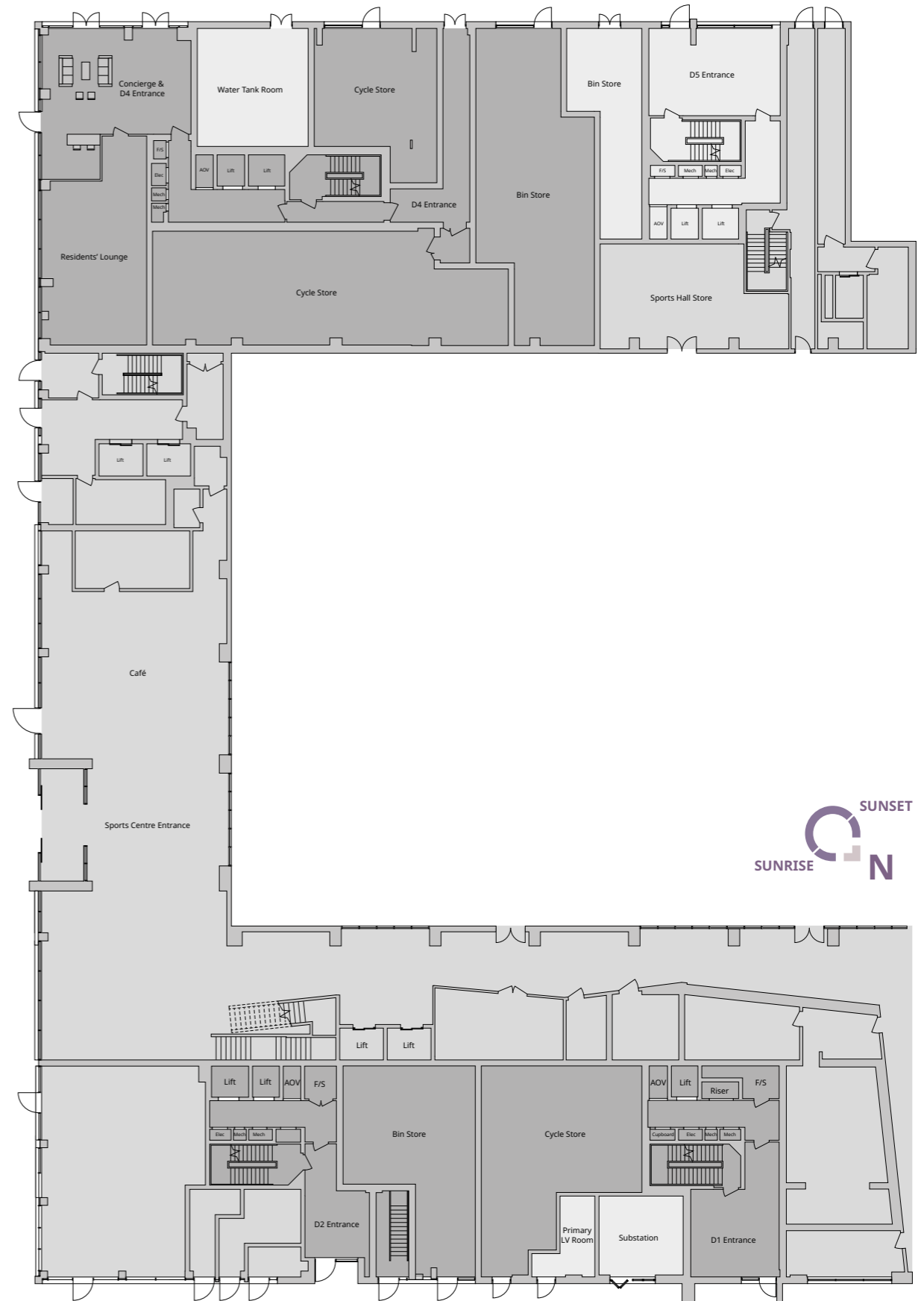
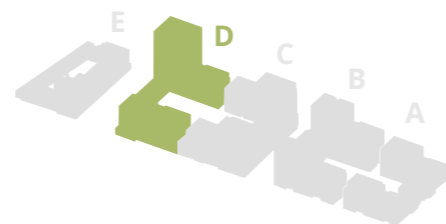

Floor plans depict a typical layout of this apartment type. For exact plot specification, details of external and internal finishes, dimensions and floor plan differences consult your sales executive. All dimensions are + or - 50mm and floor plans are not shown to scale. The kitchen layout and furniture positions are for indicative purposes only.

BLOCK D

# First Floor

NORTH WEST

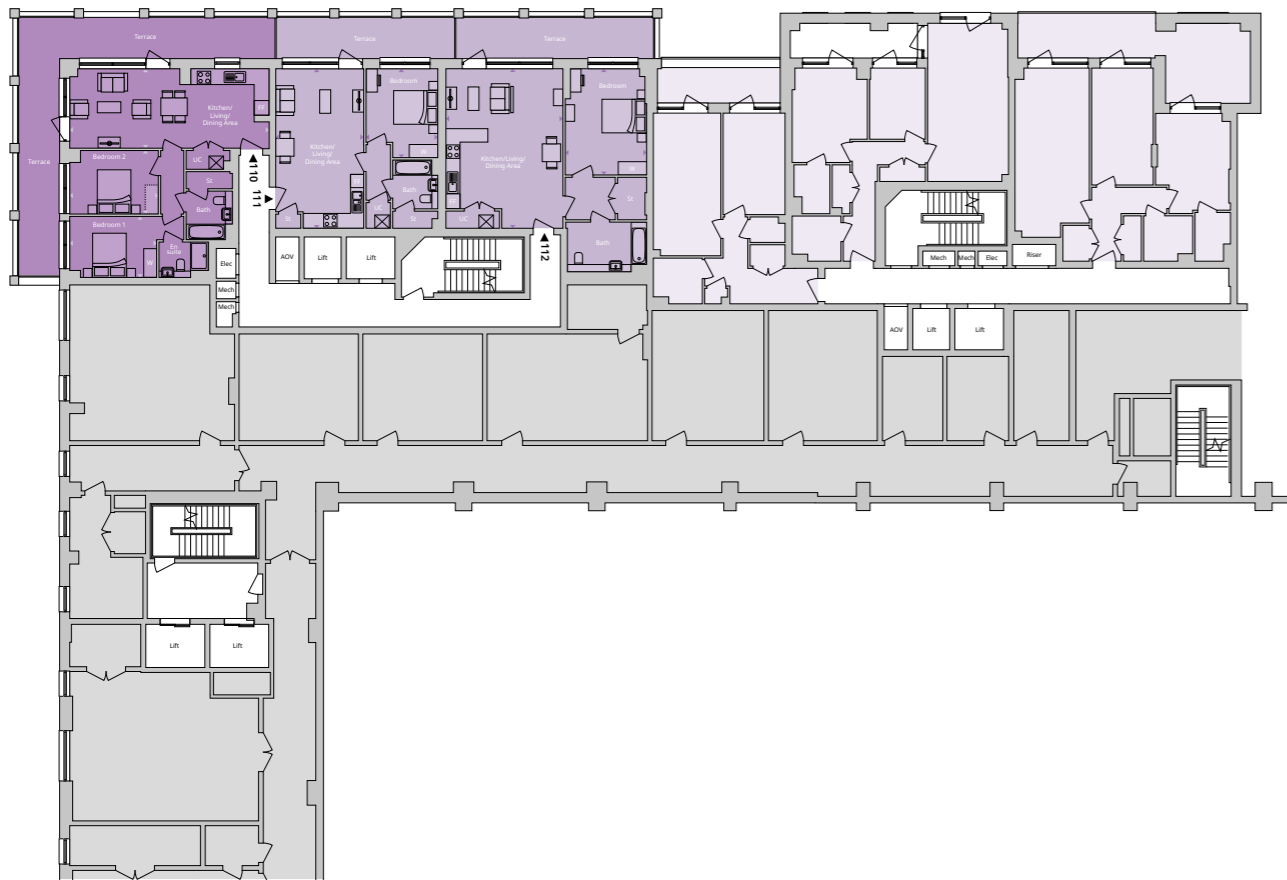
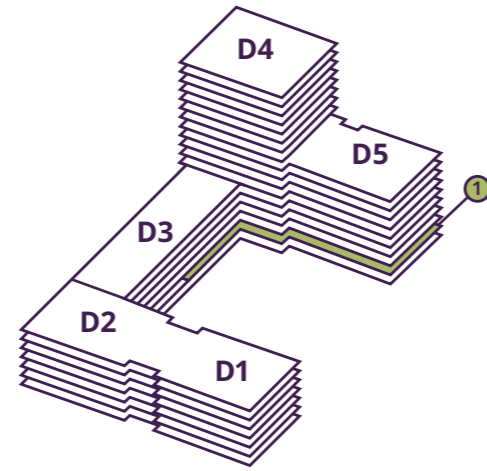

- 1 bedroom
- 2 bedroom
- Affordable housing
- Commercial area
- FF Fridge freezer
- St Storage
- UC Utility cupboard
- W Wardrobe

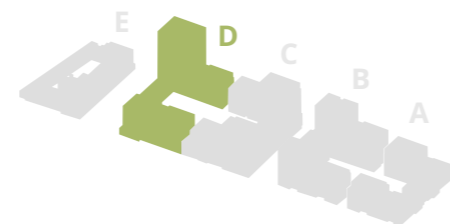

## 1 BED APARTMENTS

### Plot 111 Type CD02

#### Kitchen/Living/Dining Area

7.20m max × 4.00m max 23'7" max × 13'0" max

#### Bedroom

4.00m max × 3.30m max 13'2" max × 10'8" max

Total: 52.60 sq m | 566 sq ft

### Plot 112 Type CD31 ♿

#### Kitchen/Living/Dining Area

6.30m min × 5.30m max 20'9" min × 17'4" max

#### Bedroom

4.80m max × 3.60m max 15'9" max × 11'11" max

Total: 72.70 sq m | 783 sq ft

## 2 BED APARTMENT

### Plot 110 Type CD01

#### Kitchen/Living/Dining Area

8.90m max × 3.60m max 29'1" max × 11'10" max

#### Bedroom 1

3.90m min × 2.80m max 12'10" min × 9'0" max

#### Bedroom 2

4.00m × 2.90m 13'2" × 9'5"

Total: 72.50 sq m | 780 sq ft

Floor plans depict a typical layout of this apartment type. For exact plot specification, details of external and internal finishes, dimensions and floor plan differences consult your sales executive. All dimensions are + or - 50mm and floor plans are not shown to scale. The kitchen layout and furniture positions are for indicative purposes only. ♿ Wheelchair accessible design is available for this property type and may have features which differ from our standard apartment type. Please speak to a sales executive for further information and specification details. Apartments have openable windows either side of mullions. Please speak to your sales agent for clarification.

BLOCK D

# Second Floor

NORTH WEST

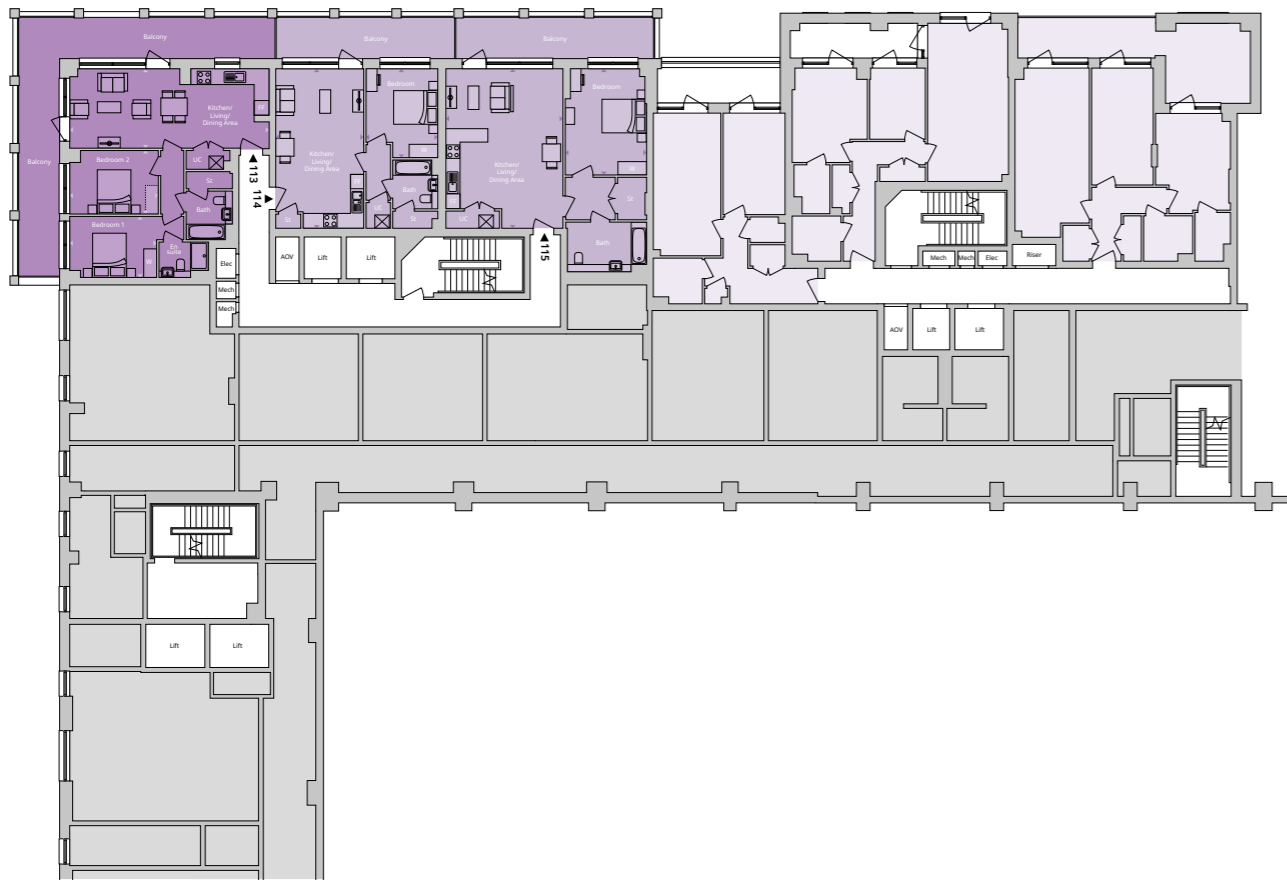
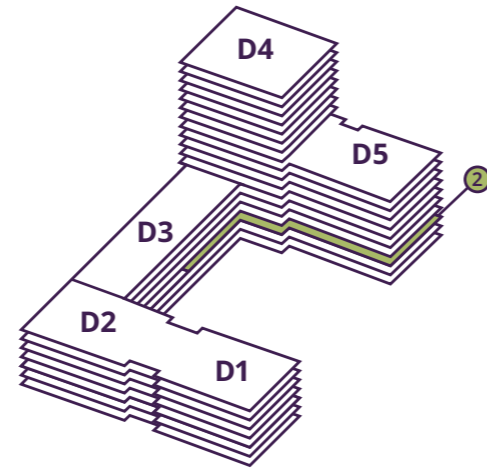

- 1 bedroom
- 2 bedroom
- Affordable housing
- Commercial area
- FF** Fridge freezer
- St** Storage
- UC** Utility cupboard
- W** Wardrobe

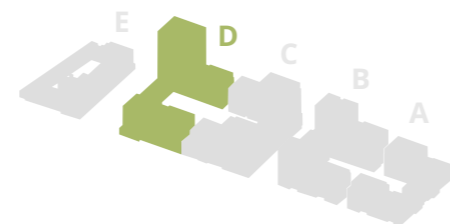

## 1 BED APARTMENTS

### Plot 114 Type CD02

#### Kitchen/Living/Dining Area

7.20m max × 4.00m max    23'7" max × 13'0" max

#### Bedroom

4.00m max × 3.30m max    13'2" max × 10'8" max

**Total: 52.60 sq m | 566 sq ft**

### Plot 115 Type CD31

#### Kitchen/Living/Dining Area

6.30m min × 5.30m max    20'9" min × 17'4" max

#### Bedroom

4.80m max × 3.60m max    15'9" max × 11'11" max

**Total: 72.70 sq m | 783 sq ft**

## 2 BED APARTMENT

### Plot 113 Type CD01

#### Kitchen/Living/Dining Area

8.90m max × 3.60m max    29'1" max × 11'10" max

#### Bedroom 1

3.90m min × 2.80m max    12'10" min × 9'0" max

#### Bedroom 2

4.00m × 2.90m                    13'2" × 9'5"

**Total: 72.50 sq m | 780 sq ft**

Floor plans depict a typical layout of this apartment type. For exact plot specification, details of external and internal finishes, dimensions and floor plan differences consult your sales executive. All dimensions are + or - 50mm and floor plans are not shown to scale. The kitchen layout and furniture positions are for indicative purposes only. Wheelchair accessible design is available for this property type and may have features which differ from our standard apartment type. Please speak to a sales executive for further information and specification details. Apartments have openable windows either side of mullions. Please speak to your sales agent for clarification.



BLOCK D

# Third Floor

NORTH WEST

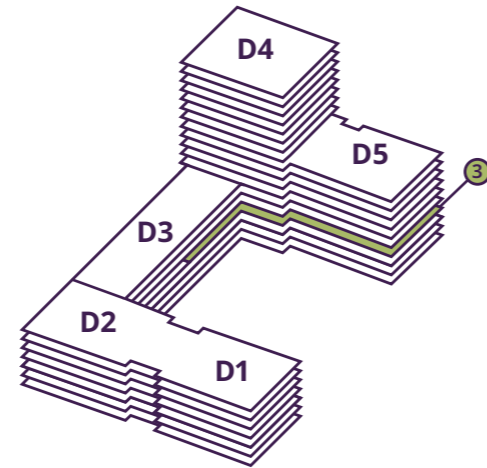

- 1 bedroom
- 2 bedroom
- Affordable housing
- Commercial area
- FF Fridge freezer
- P Pantry
- St Storage
- UC Utility cupboard
- W Wardrobe

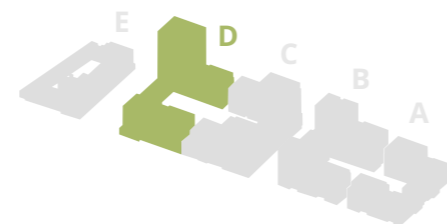

## 1 BED APARTMENTS

### Plot 117 Type CD02

**Kitchen/Living/Dining Area**  
7.20m max × 4.00m max 23'7" max × 13'0" max

**Bedroom**  
4.00m max × 3.30m max 13'2" max × 10'8" max

**Total: 52.60 sq m | 566 sq ft**

### Plot 118 Type CD31

**Kitchen/Living/Dining Area**  
6.30m min × 5.30m max 20'9" min × 17'4" max

**Bedroom**  
4.80m max × 3.60m max 15'9" max × 11'11" max

**Total: 72.70 sq m | 783 sq ft**

### Plot 119 Type CD18

**Kitchen/Living/Dining Area**  
8.60m max × 3.60m max 28'2" max × 11'10" max

**Bedroom**  
4.90m max × 3.20m max 16'1" max × 10'4" max

**Total: 57.40 sq m | 618 sq ft**

### Plot 120 Type CD35

**Kitchen/Living/Dining Area**  
7.20m max × 3.60m max 23'7" max × 11'10" max

**Bedroom**  
4.00m max × 3.60m max 13'2" max × 11'10" max

**Total: 52.60 sq m | 566 sq ft**

## 2 BED APARTMENTS

### Plot 116 Type CD01

**Kitchen/Living/Dining Area**  
8.90m max × 3.60m max 29'1" max × 11'10" max

**Bedroom 1**  
3.90m min × 2.80m max 12'10" min × 9'0" max

**Bedroom 2**  
4.00m × 2.90m 13'2" × 9'5"

**Total: 72.50 sq m | 780 sq ft**

### Plot 121 Type CD01

**Kitchen/Living/Dining Area**  
8.90m max × 3.60m max 29'1" max × 11'10" max

**Bedroom 1**  
3.90m min × 2.80m max 12'10" min × 9'0" max

**Bedroom 2**  
4.00m × 2.90m 13'2" × 9'5"

**Total: 72.50 sq m | 780 sq ft**

Floor plans depict a typical layout of this apartment type. For exact plot specification, details of external and internal finishes, dimensions and floor plan differences consult your sales executive. All dimensions are + or - 50mm and floor plans are not shown to scale. The kitchen layout and furniture positions are for indicative purposes only. Wheelchair accessible design is available for this property type and may have features which differ from our standard apartment type. Please speak to a sales executive for further information and specification details. Apartments have openable windows either side of mullions. Please speak to your sales agent for clarification.

BLOCK D

# Third Floor

NORTH EAST

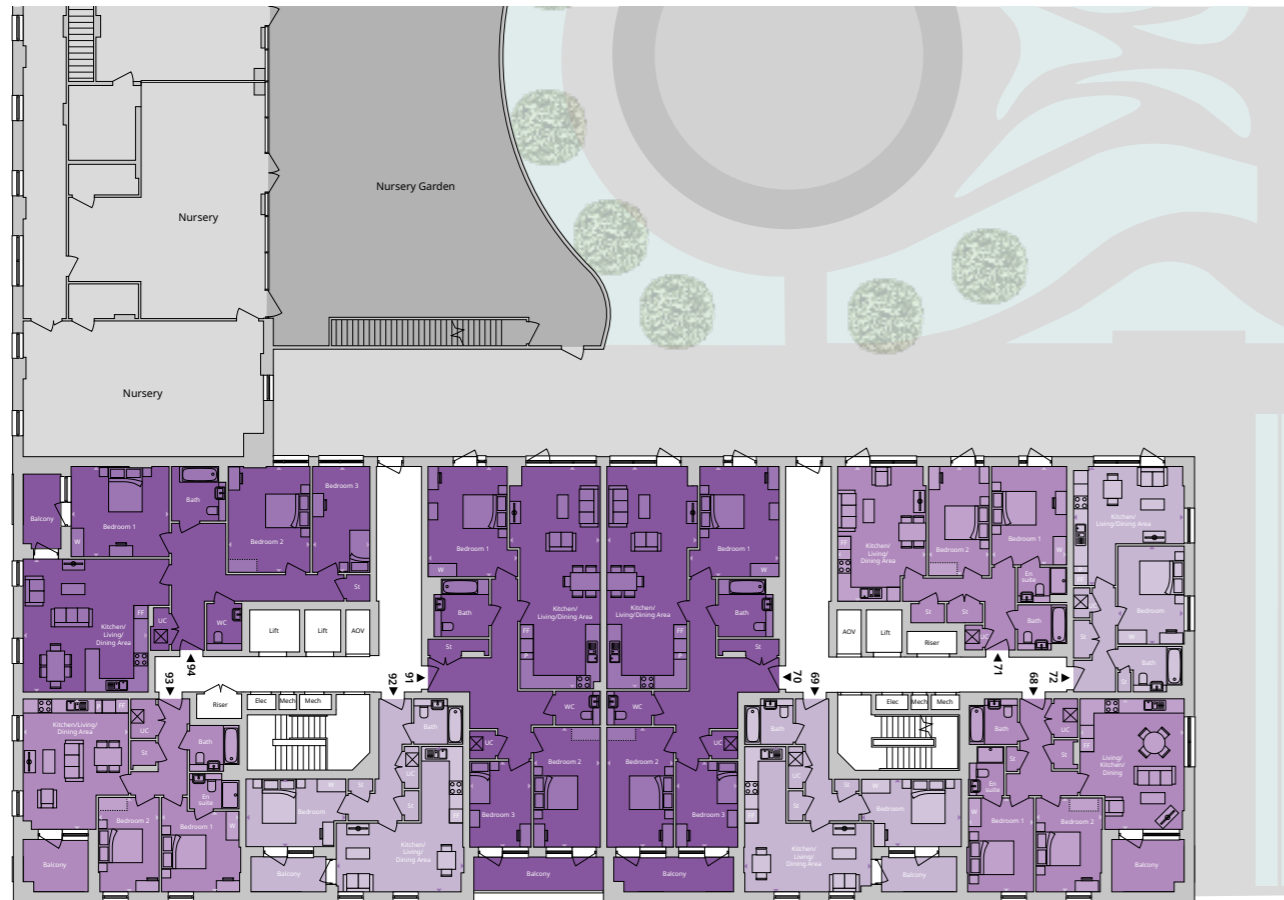
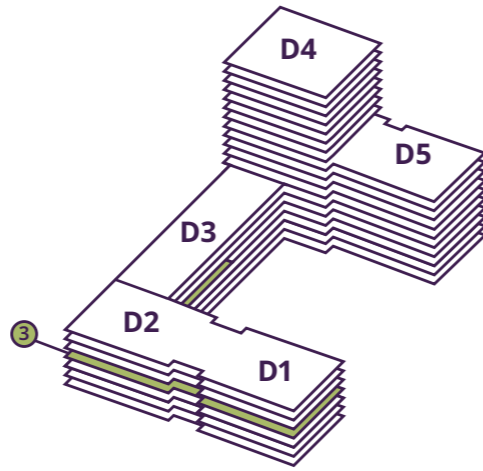

- 1 bedroom
- 2 bedroom
- 3 bedroom
- Affordable housing
- Commercial area
- FF Fridge freezer
- P Pantry
- St Storage
- UC Utility cupboard
- W Wardrobe
- WC Washroom
- Indicative wardrobe space

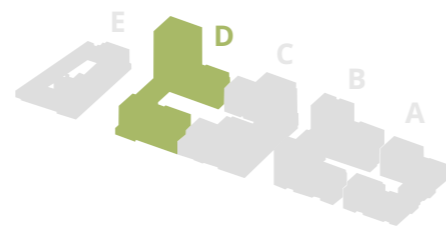

## 1 BED APARTMENTS

### Plot 69 Type CD08

Kitchen/Living/Dining Area  
6.50m max x 5.70m max 21'5" max x 18'9" max

Bedroom  
4.50m max x 3.10m max 14'9" max x 10'0" max

Total: 54.90 sq m | 591 sq ft

### Plot 72 Type CD04

Kitchen/Living/Dining Area  
5.40m max x 5.00m max 17'4" max x 16'4" max

Bedroom  
4.40m max x 3.00m max 14'6" max x 9'10" max

Total: 50.60 sq m | 545 sq ft

### Plot 92 Type CD08

Kitchen/Living/Dining Area  
6.50m max x 5.70m max 21'5" max x 18'9" max

Bedroom  
4.50m max x 3.10m max 14'9" max x 10'0" max

Total: 54.90 sq m | 591 sq ft

## 2 BED APARTMENTS

### Plot 68 Type CD33

Kitchen/Living/Dining Area  
5.90m max x 4.70m max 19'3" max x 15'5" max

Bedroom 1  
4.20m x 3.00m 13'11" x 9'9"

Bedroom 2  
4.20m x 2.80m 13'11" x 9'1"

Total: 73.70 sq m | 793 sq ft

### Plot 71 Type CD34

Kitchen/Living/Dining Area  
6.10m max x 4.00m max 19'11" max x 13'1" max

Bedroom 1  
4.40m x 3.40m 14'6" x 11'1"

Bedroom 2  
4.90m x 2.80m 16'2" x 9'0"

Total: 74.70 sq m | 566 sq ft

### Plot 93 Type CD17

Kitchen/Living/Dining Area  
5.90m max x 4.70m max 19'3" max x 15'7" max

Bedroom 1  
3.70m min x 3.50m max 12'0" min x 11'5" max

Bedroom 2  
4.30m max x 2.80m max 14'0" max x 9'1" max

Total: 72.00 sq m | 775 sq ft

## 3 BED APARTMENTS

### Plot 70 Type CD23 ♿

Kitchen/Living/Dining Area  
10.00m max x 4.07m max 32'10" max x 13'4" max

Bedroom 1  
5.12m max x 4.05m max 16'9" max x 13'3" max

Bedroom 2  
5.37m x 3.00m 17'7" x 9'10"

Bedroom 3  
3.86m x 2.78m 12'8" x 9'1"

Total: 119.50 sq m | 1,286 sq ft

### Plot 91 Type CD23

Kitchen/Living/Dining Area  
10.00m max x 4.07m max 32'10" max x 13'4" max

Bedroom 1  
5.12m max x 4.05m max 16'9" max x 13'3" max

Bedroom 2  
5.37m x 3.00m 17'7" x 9'10"

Bedroom 3  
3.86m x 2.78m 12'8" x 9'1"

Total: 119.50 sq m | 1,286 sq ft

### Plot 94 Type CD13 ♿

Kitchen/Living/Dining Area  
6.60m max x 6.00m max 21'6" max x 19'7" max

Bedroom 1  
4.40m max x 4.10m max 14'4" max x 13'4" max

Bedroom 2  
4.80m max x 3.70m max 15'8" max x 12'2" max

Bedroom 3  
4.80m x 2.60m 15'8" x 8'5"

Total: 118.20 sq m | 1,272 sq ft

Floor plans depict a typical layout of this apartment type. For exact plot specification, details of external and internal finishes, dimensions and floor plan differences consult your sales executive. All dimensions are + or - 50mm and floor plans are not shown to scale. The kitchen layout and furniture positions are for indicative purposes only. ♿ Wheelchair accessible design is available for this property type and may have features which differ from our standard apartment type. Please speak to a sales executive for further information and specification details. Apartments have openable windows either side of mullions. Please speak to your sales agent for clarification.

BLOCK D

# Fourth Floor

NORTH WEST

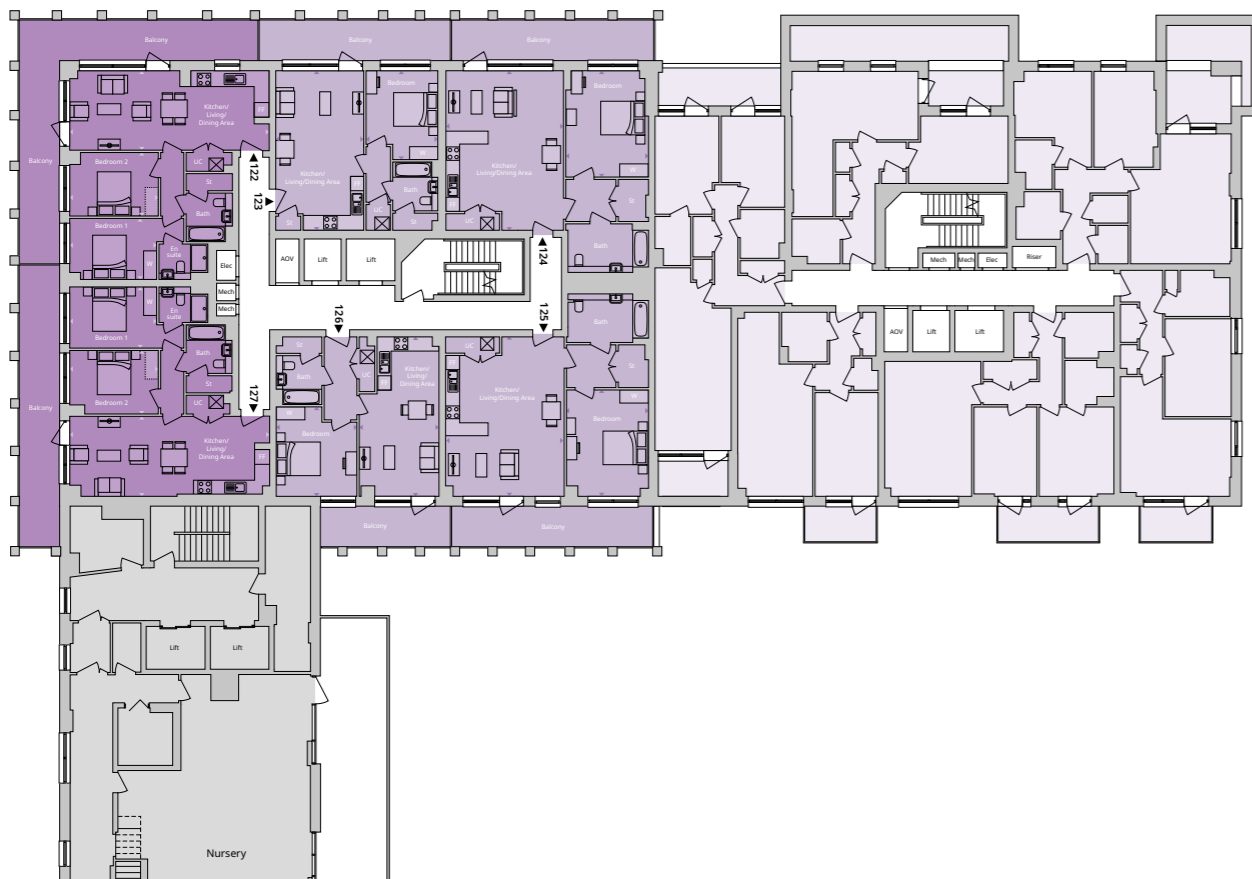
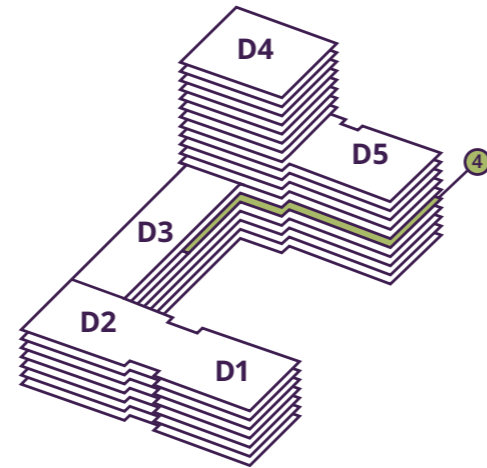

- 1 bedroom
- 2 bedroom
- Affordable housing
- Commercial area
- FF Fridge freezer
- St Storage
- UC Utility cupboard
- W Wardrobe
- Indicative wardrobe space

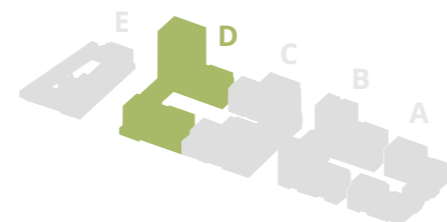

## 1 BED APARTMENTS

### Plot 123 Type CD02

**Kitchen/Living/Dining Area**  
7.20m max × 4.00m max 23'7" max × 13'0" max

**Bedroom**  
4.00m max × 3.30m max 13'2" max × 10'8" max

**Total: 52.60 sq m | 566 sq ft**

### Plot 124 Type CD31 ♿

**Kitchen/Living/Dining Area**  
6.30m min × 5.30m max 20'9" min × 17'4" max

**Bedroom**  
4.80m max × 3.60m max 15'9" max × 11'11" max

**Total: 72.70 sq m | 783 sq ft**

### Plot 125 Type CD31 ♿

**Kitchen/Living/Dining Area**  
6.30m min × 5.30m max 20'9" min × 17'4" max

**Bedroom**  
4.80m max × 3.60m max 15'9" max × 11'11" max

**Total: 72.70 sq m | 783 sq ft**

### Plot 126 Type CD35

**Kitchen/Living/Dining Area**  
7.20m max × 3.60m max 23'7" max × 11'10" max

**Bedroom**  
4.00m max × 3.60m max 13'2" max × 11'10" max

**Total: 52.60 sq m | 566 sq ft**

## 2 BED APARTMENTS

### Plot 122 Type CD01

**Kitchen/Living/Dining Area**  
8.90m max × 3.60m max 29'1" max × 11'10" max

**Bedroom 1**  
3.90m min × 2.80m max 12'10" min × 9'0" max

**Bedroom 2**  
4.00m × 2.90m 13'2" × 9'5"

**Total: 72.50 sq m | 780 sq ft**

### Plot 127 Type CD01

**Kitchen/Living/Dining Area**  
8.90m max × 3.60m max 29'1" max × 11'10" max

**Bedroom 1**  
3.90m min × 2.80m max 12'10" min × 9'0" max

**Bedroom 2**  
4.00m × 2.90m 13'2" × 9'5"

**Total: 72.50 sq m | 780 sq ft**

Floor plans depict a typical layout of this apartment type. For exact plot specification, details of external and internal finishes, dimensions and floor plan differences consult your sales executive. All dimensions are + or - 50mm and floor plans are not shown to scale. The kitchen layout and furniture positions are for indicative purposes only. ♿ Wheelchair accessible design is available for this property type and may have features which differ from our standard apartment type. Please speak to a sales executive for further information and specification details. Apartments have openable windows either side of mullions. Please speak to your sales agent for clarification.

BLOCK D

# Fourth Floor

NORTH EAST

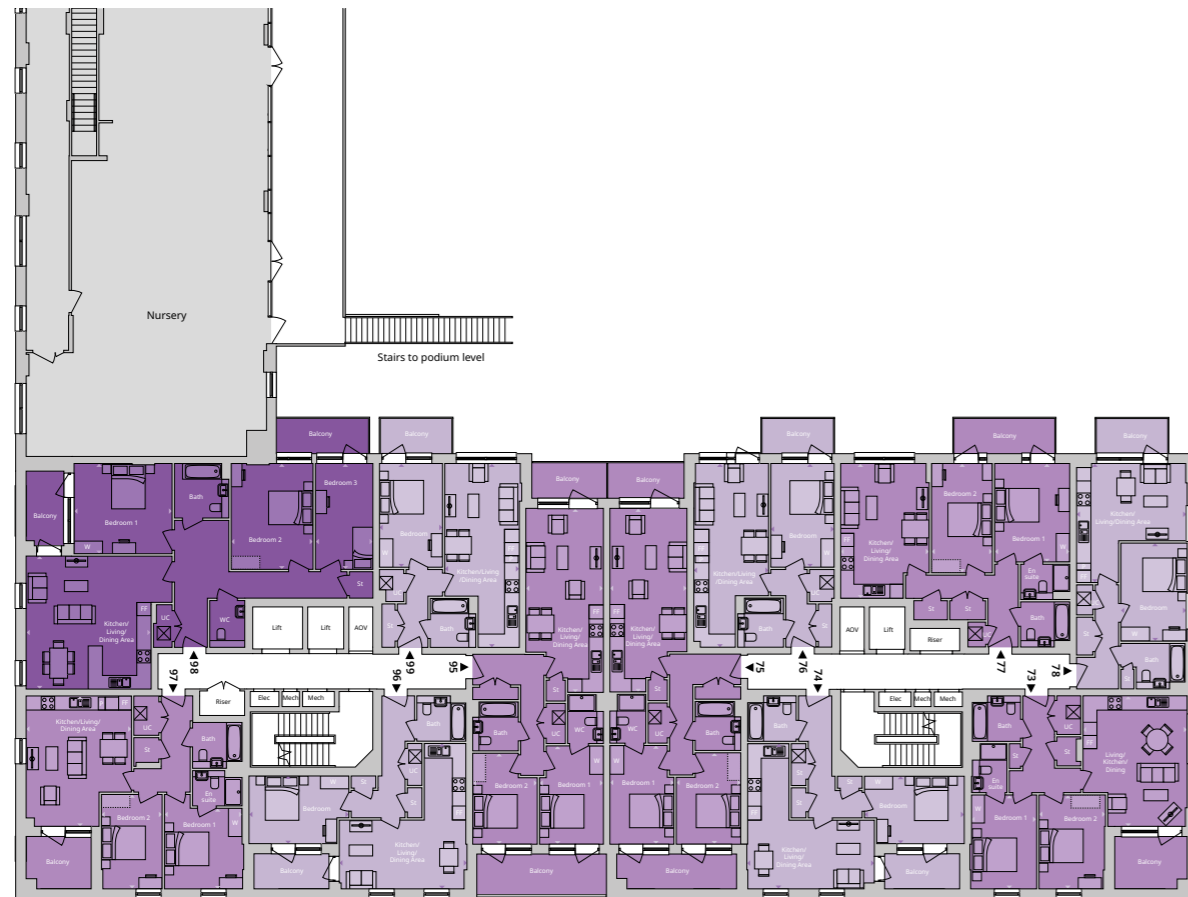
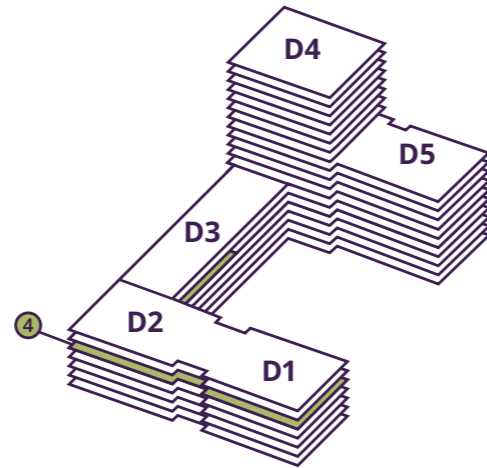

- 1 bedroom
- 2 bedroom
- 3 bedroom
- Commercial area
- FF Fridge freezer
- P Pantry
- St Storage
- UC Utility cupboard
- W Wardrobe
- WC Washroom
- Indicative wardrobe space

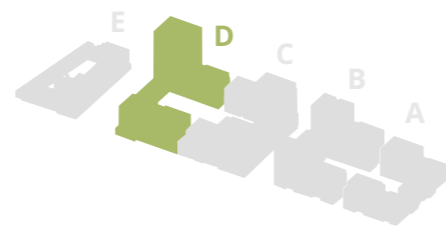

## 1 BED APARTMENTS

### Plot 74 Type CD08

**Kitchen/Living/Dining Area**  
6.50m max × 5.70m max 21'5" max × 18'9" max

**Bedroom**  
4.50m max × 3.10m max 14'9" max × 10'0" max

**Total: 54.90 sq m | 591 sq ft**

### Plot 76 Type CD06

**Kitchen/Living/Dining Area**  
8.25m max × 3.34m max 27'1" max × 10'11" max

**Bedroom**  
4.67m × 2.85m 15'4" × 9'4"

**Total: 51.10 sq m | 550 sq ft**

### Plot 78 Type CD04

**Kitchen/Living/Dining Area**  
5.40m max × 5.00m max 17'4" max × 16'4" max

**Bedroom**  
4.40m max × 3.00m max 14'6" max × 9'10" max

**Total: 50.60 sq m | 545 sq ft**

### Plot 96 Type CD08

**Kitchen/Living/Dining Area**  
6.50m max × 5.70m max 21'5" max × 18'9" max

**Bedroom**  
4.50m max × 3.10m max 14'9" max × 10'0" max

**Total: 54.90 sq m | 591 sq ft**

### Plot 99 Type CD06

**Kitchen/Living/Dining Area**  
8.25m max × 3.34m max 27'1" max × 10'11" max

**Bedroom**  
4.67m × 2.85m 15'4" × 9'4"

**Total: 51.10 sq m | 550 sq ft**

## 2 BED APARTMENTS

### Plot 73 Type CD33

**Kitchen/Living/Dining Area**  
5.90m max × 4.70m max 19'3" max × 15'5" max

**Bedroom 1**  
4.20m × 3.00m 13'11" × 9'9"

**Bedroom 2**  
4.20m × 2.80m 13'11" × 9'1"

**Total: 73.70 sq m | 793 sq ft**

### Plot 75 Type CD07

**Kitchen/Living/Dining Area**  
8.20m max × 3.60m max 27'0" max × 11'11" max

**Bedroom 1**  
4.40m max × 3.10m max 14'7" max × 10'1" max

**Bedroom 2**  
3.00m min × 2.90m max 9'10" min × 9'5" max

**Total: 72.80 sq m | 784 sq ft**

### Plot 77 Type CD34

**Kitchen/Living/Dining Area**  
6.10m max × 4.00m max 19'11" max × 13'1" max

**Bedroom 1**  
4.40m × 3.40m 14'6" × 11'1"

**Bedroom 2**  
4.90m × 2.80m 16'2" × 9'0"

**Total: 74.70 sq m | 804 sq ft**

### Plot 95 Type CD07

**Kitchen/Living/Dining Area**  
8.20m max × 3.60m max 27'0" max × 11'11" max

**Bedroom 1**  
4.40m max × 3.10m max 14'7" max × 10'1" max

**Bedroom 2**  
3.00m min × 2.90m max 9'10" min × 9'5" max

**Total: 72.80 sq m | 784 sq ft**

### Plot 97 Type CD17

**Kitchen/Living/Dining Area**  
5.90m max × 4.70m max 19'3" max × 15'7" max

**Bedroom 1**  
3.70m min × 3.50m max 12'0" min × 11'5" max

**Bedroom 2**  
4.30m max × 2.80m max 14'0" max × 9'1" max

**Total: 72.00 sq m | 775 sq ft**

## 3 BED APARTMENT

### Plot 98 Type CD13

**Kitchen/Living/Dining Area**  
6.60m max × 6.00m max 21'6" max × 19'7" max

**Bedroom 1**  
4.40m max × 4.10m max 14'4" max × 13'4" max

**Bedroom 2**  
4.80m max × 3.70m max 15'8" max × 12'2" max

**Bedroom 3**  
4.80m × 2.60m 15'8" × 8'5"

**Total: 118.20 sq m | 1,272 sq ft**

Floor plans depict a typical layout of this apartment type. For exact plot specification, details of external and internal finishes, dimensions and floor plan differences consult your sales executive. All dimensions are + or - 50mm and floor plans are not shown to scale. The kitchen layout and furniture positions are for indicative purposes only. Wheelchair accessible design is available for this property type and may have features which differ from our standard apartment type. Please speak to a sales executive for further information and specification details. Apartments have operable windows either side of mullions. Please speak to your sales agent for clarification.

BLOCK D

# Fifth Floor

NORTH WEST

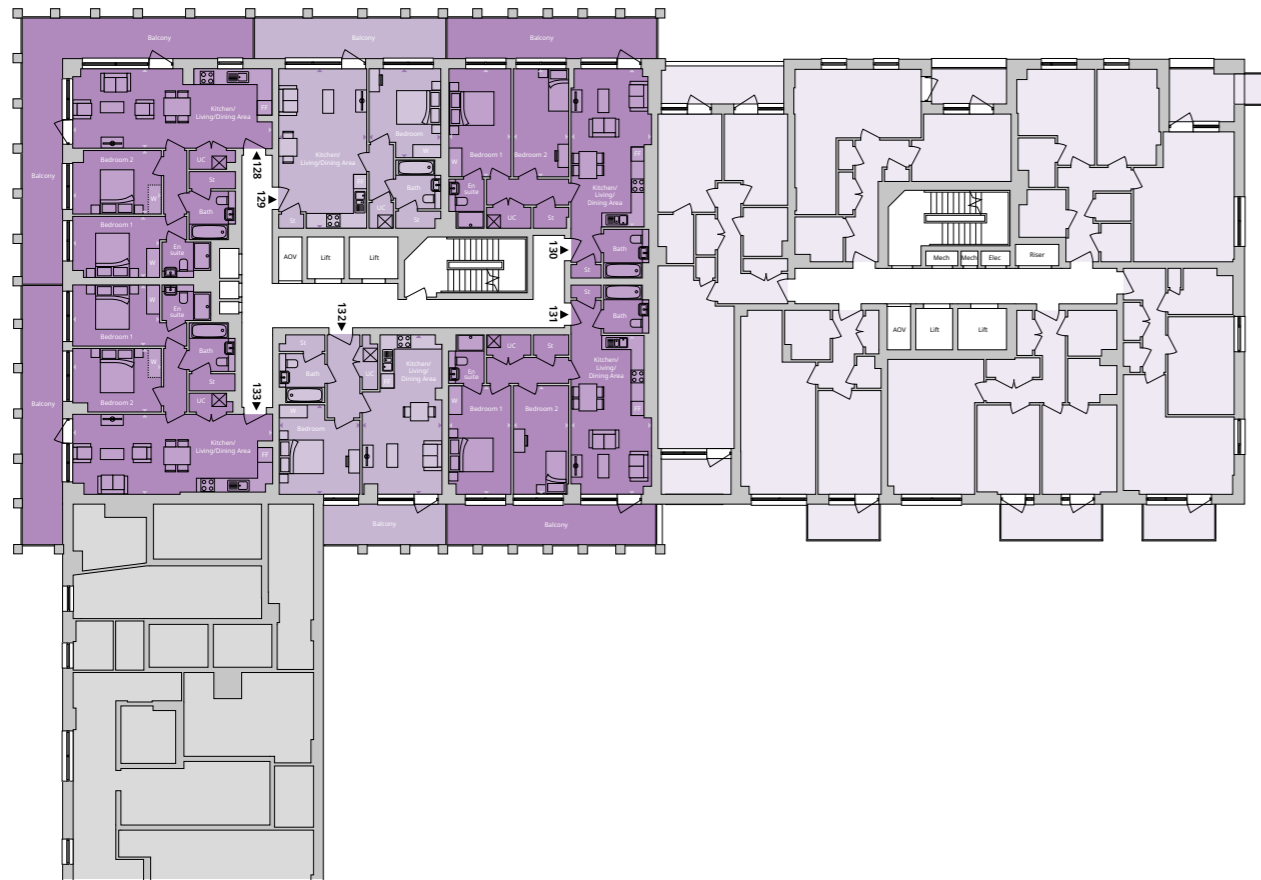
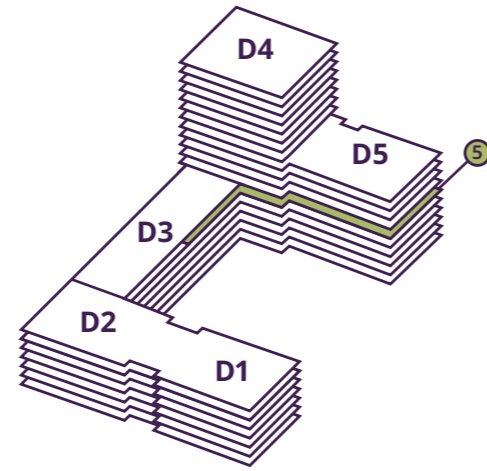

## 1 BED APARTMENTS

### Plot 129 Type CD02

**Kitchen/Living/Dining Area**  
7.20m max × 4.00m max 23'7" max × 13'0" max

**Bedroom**  
4.00m max × 3.30m max 13'2" max × 10'8" max

**Total: 52.60 sq m | 566 sq ft**

### Plot 132 Type CD35

**Kitchen/Living/Dining Area**  
7.20m max × 3.60m max 23'7" max × 11'10" max

**Bedroom**  
4.00m max × 3.60m max 13'2" max × 11'10" max

**Total: 52.60 sq m | 566 sq ft**

## 2 BED APARTMENTS

### Plot 128 Type CD01

**Kitchen/Living/Dining Area**  
8.90m max × 3.60m max 29'1" max × 11'10" max

**Bedroom 1**  
3.90m min × 2.80m max 12'10" min × 9'0" max

**Bedroom 2**  
4.00m × 2.90m 13'2" × 9'5"

**Total: 72.50 sq m | 780 sq ft**

### Plot 130 Type CD03

**Kitchen/Living/Dining Area**  
7.10m min × 3.06m max 23'4" min × 11'10" max

**Bedroom 1**  
4.90m max × 2.80m max 16'1" max × 9'11" max

**Bedroom 2**  
4.90m × 2.50m max 16'1" × 8'3" max

**Total: 73.50 sq m | 791 sq ft**

### Plot 131 Type CD03

**Kitchen/Living/Dining Area**  
7.10m min × 3.60m max 23'4" min × 11'10" max

**Bedroom 1**  
4.90m max × 2.80m max 16'1" max × 9'11" max

**Bedroom 2**  
4.90m × 2.50m max 16'1" × 8'3" max

**Total: 73.50 sq m | 791 sq ft**

### Plot 133 Type CD01

**Kitchen/Living/Dining Area**  
8.90m max × 3.60m max 29'1" max × 11'10" max

**Bedroom 1**  
3.90m min × 2.80m max 12'10" min × 9'0" max

**Bedroom 2**  
4.00m × 2.90m 13'2" × 9'5"

**Total: 72.50 sq m | 780 sq ft**

- 1 bedroom
- 2 bedroom
- Affordable housing
- Commercial area
- FF Fridge freezer
- St Storage
- UC Utility cupboard
- W Wardrobe
- Indicative wardrobe space

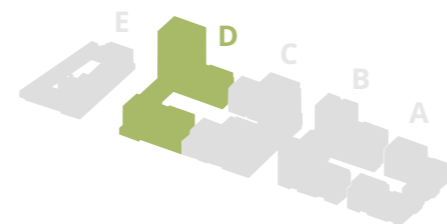

Floor plans depict a typical layout of this apartment type. For exact plot specification, details of external and internal finishes, dimensions and floor plan differences consult your sales executive. All dimensions are + or - 50mm and floor plans are not shown to scale. The kitchen layout and furniture positions are for indicative purposes only. ♿ Wheelchair accessible design is available for this property type and may have features which differ from our standard apartment type. Please speak to a sales executive for further information and specification details. Apartments have openable windows either side of mullions. Please speak to your sales agent for clarification.

BLOCK D

# Fifth Floor

NORTH EAST

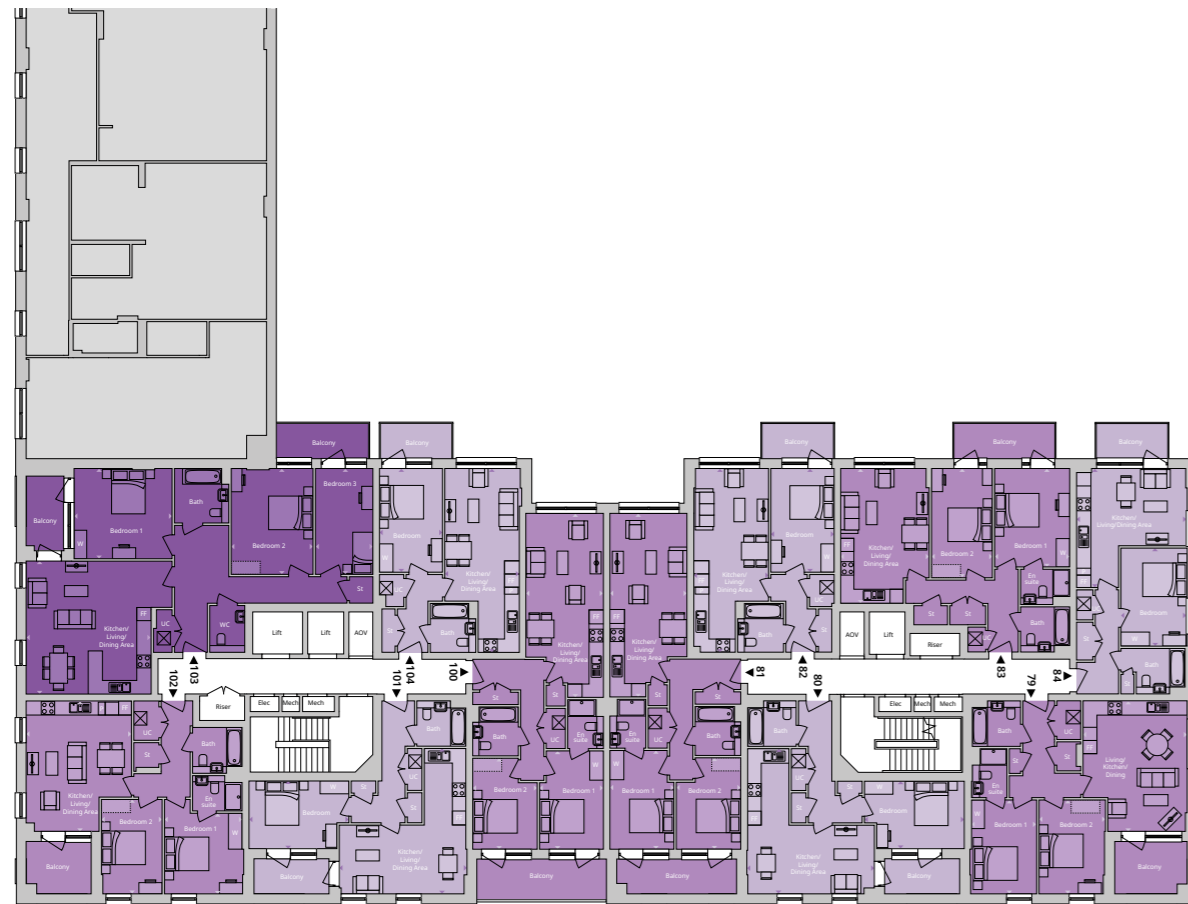
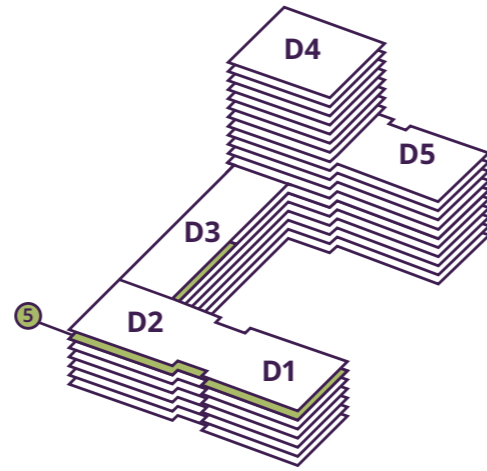

- 1 bedroom
- 2 bedroom
- 3 bedroom
- Commercial area

- FF Fridge freezer
- P Pantry
- St Storage
- UC Utility cupboard
- W Wardrobe
- WC Washroom
- Indicative wardrobe space

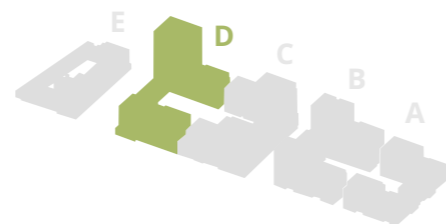

## 1 BED APARTMENTS

### Plot 80 Type CD08

**Kitchen/Living/Dining Area**  
6.50m max × 5.70m max 21'5" max × 18'9" max

**Bedroom**  
4.50m max × 3.10m max 14'9" max × 10'0" max

**Total: 54.90 sq m | 591 sq ft**

### Plot 82 Type CD06

**Kitchen/Living/Dining Area**  
8.25m max × 3.34 m max 27'1" max × 10'11" max

**Bedroom**  
4.67m × 2.85 m 15'4" × 9'4"

**Total: 51.10 sq m | 550 sq ft**

### Plot 84 Type CD04

**Kitchen/Living/Dining Area**  
5.40m max × 5.00m max 17'4" max × 16'4" max

**Bedroom**  
4.40m max × 3.00m max 14'6" max × 9'10" max

**Total: 50.60 sq m | 545 sq ft**

### Plot 101 Type CD08

**Kitchen/Living/Dining Area**  
6.50m max × 5.70m max 21'5" max × 18'9" max

**Bedroom**  
4.50m max × 3.10m max 14'9" max × 10'0" max

**Total: 54.90 sq m | 591 sq ft**

### Plot 104 Type CD06

**Kitchen/Living/Dining Area**  
8.25m max × 3.34m max 27'1" max × 10'11" max

**Bedroom**  
4.67m × 2.85m 15'4" × 9'4"

**Total: 51.10 sq m | 550 sq ft**

## 2 BED APARTMENTS

### Plot 79 Type CD33

**Kitchen/Living/Dining Area**  
5.90m max × 4.70m max 19'3" max × 15'5" max

**Bedroom 1**  
4.20m × 3.00m 13'11" × 9'9"

**Bedroom 2**  
4.20m × 2.80m 13'11" × 9'1"

**Total: 73.70 sq m | 793 sq ft**

### Plot 81 Type CD07

**Kitchen/Living/Dining Area**  
8.20m max × 3.60m max 27'0" max × 11'11" max

**Bedroom 1**  
4.40m max × 3.10m max 14'7" max × 10'1" max

**Bedroom 2**  
3.00m min × 2.90m max 9'10" min × 9'5" max

**Total: 72.80 sq m | 784 sq ft**

### Plot 83 Type CD34

**Kitchen/Living/Dining Area**  
6.10m max × 4.00m max 19'11" max × 13'1" max

**Bedroom 1**  
4.40m × 3.40m 14'6" × 11'1"

**Bedroom 2**  
4.90m × 2.80m 16'2" × 9'0"

**Total: 74.70 sq m | 804 sq ft**

### Plot 100 Type CD07

**Kitchen/Living/Dining Area**  
8.20m max × 3.60m max 27'0" max × 11'11" max

**Bedroom 1**  
4.40m max × 3.10m max 14'7" max × 10'1" max

**Bedroom 2**  
3.00m min × 2.90m max 9'10" min × 9'5" max

**Total: 72.80 sq m | 784 sq ft**

### Plot 102 Type CD17

**Kitchen/Living/Dining Area**  
5.90m max × 4.70m max 19'3" max × 15'7" max

**Bedroom 1**  
3.70m min × 3.50m max 12'0" min × 11'5" max

**Bedroom 2**  
4.30m max × 2.80m max 14'0" max × 9'1" max

**Total: 72.00 sq m | 775 sq ft**

## 3 BED APARTMENT

### Plot 103 Type CD13

**Kitchen/Living/Dining Area**  
6.60m max × 6.00m max 21'6" max × 19'7" max

**Bedroom 1**  
4.40m max × 4.10m max 14'4" max × 13'4" max

**Bedroom 2**  
4.80m max × 3.70m max 15'8" max × 12'2" max

**Bedroom 3**  
4.80m × 2.60m 15'8" × 8'5"

**Total: 118.20 sq m | 1,272 sq ft**

Floor plans depict a typical layout of this apartment type. For exact plot specification, details of external and internal finishes, dimensions and floor plan differences consult your sales executive. All dimensions are + or - 50mm and floor plans are not shown to scale. The kitchen layout and furniture positions are for indicative purposes only. Wheelchair accessible design is available for this property type and may have features which differ from our standard apartment type. Please speak to a sales executive for further information and specification details. Apartments have operable windows either side of mullions. Please speak to your sales agent for clarification.

BLOCK D

# Sixth Floor

NORTH WEST

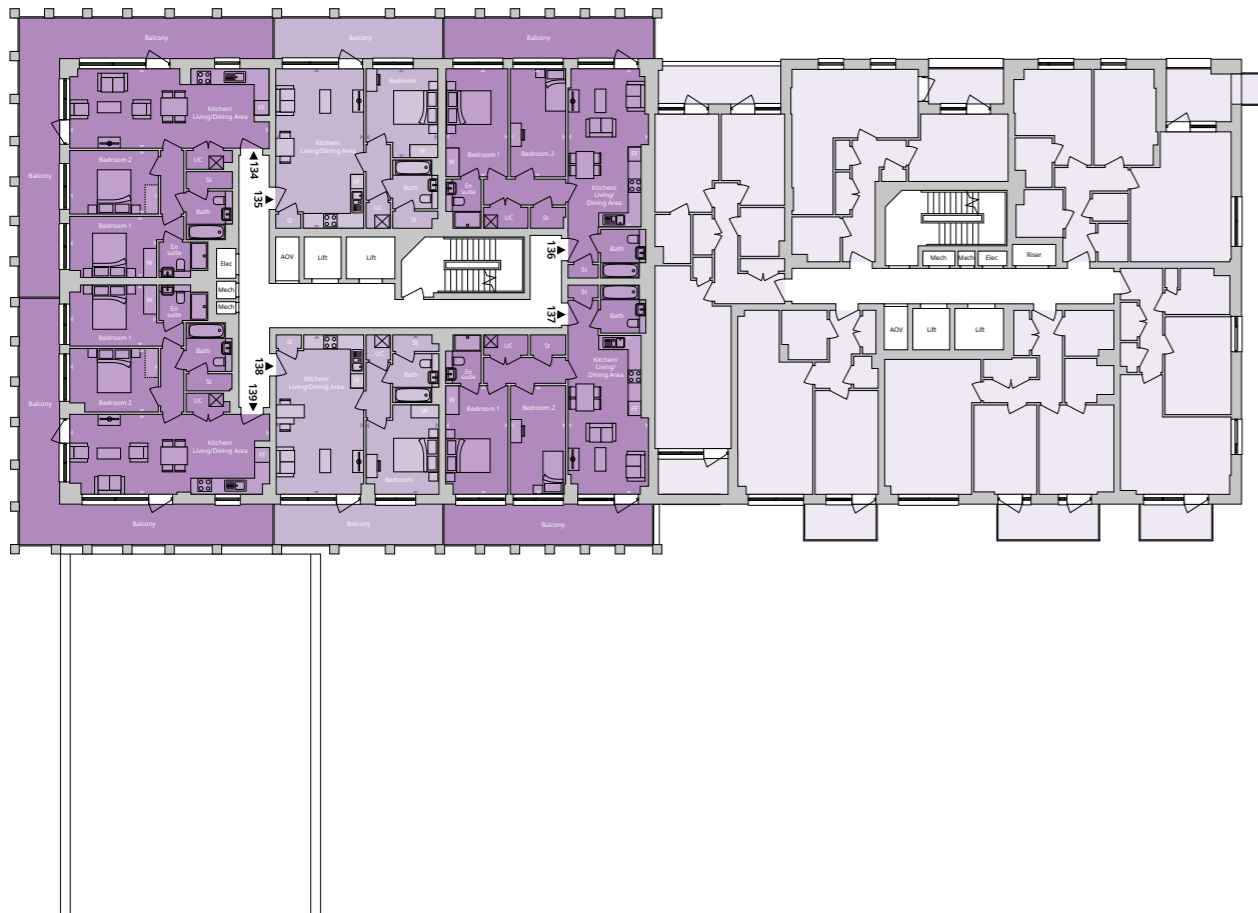
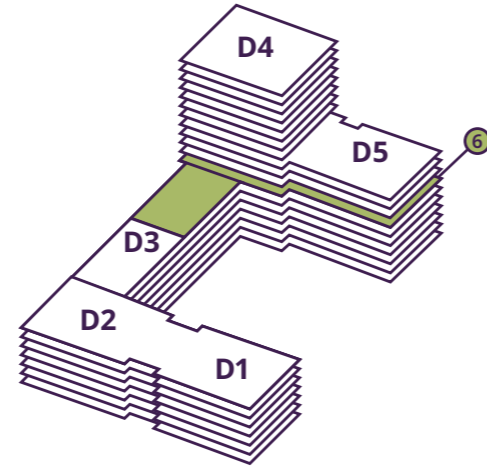

- 1 bedroom
- 2 bedroom
- 3 bedroom
- Affordable housing
- Commercial area
- FF Fridge freezer
- St Storage
- UC Utility cupboard
- W Wardrobe
- Indicative wardrobe space

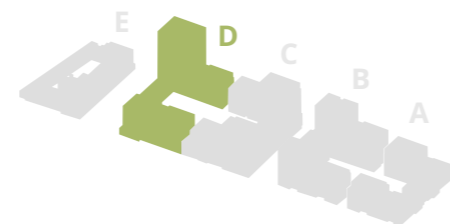

## 1 BED APARTMENTS

### Plot 135 Type CD02

Kitchen/Living/Dining Area  
7.20m max × 4.00m max 23'7" max × 13'0" max

Bedroom  
4.00m max × 3.30m max 13'2" max × 10'8" max

Total: 52.60 sq m | 566 sq ft

### Plot 138 Type CD02

Kitchen/Living/Dining Area  
7.20m max × 4.00m max 23'7" max × 13'0" max

Bedroom  
4.00m max × 3.30m max 13'2" max × 10'8" max

Total: 52.60 sq m | 566 sq ft

## 2 BED APARTMENTS

### Plot 134 Type CD01

Kitchen/Living/Dining Area  
8.90m max × 3.60m max 29'1" max × 11'10" max

Bedroom 1  
3.90m min × 2.80m max 12'10" min × 9'0" max

Bedroom 2  
4.00m × 2.90m 13'2" × 9'5"

Total: 72.50 sq m | 780 sq ft

### Plot 136 Type CD03

Kitchen/Living/Dining Area  
7.10m min × 3.60m max 23'4" min × 11'10" max

Bedroom 1  
4.90m max × 2.80m max 16'1" max × 9'11" max

Bedroom 2  
4.90m × 2.50m max 16'1" × 8'3" max

Total: 73.50 sq m | 791 sq ft

### Plot 137 Type CD03

Kitchen/Living/Dining Area  
7.10m min × 3.60m max 23'4" min × 11'10" max

Bedroom 1  
4.90m max × 2.80m max 16'1" max × 9'11" max

Bedroom 2  
4.90m × 2.50m max 16'1" × 8'3" max

Total: 73.50 sq m | 791 sq ft

### Plot 139 Type CD01

Kitchen/Living/Dining Area  
8.90m max × 3.60m max 29'1" max × 11'10" max

Bedroom 1  
3.90m min × 2.80m max 12'10" min × 9'0" max

Bedroom 2  
4.00m × 2.90m 13'2" × 9'5"

Total: 72.50 sq m | 780 sq ft

Floor plans depict a typical layout of this apartment type. For exact plot specification, details of external and internal finishes, dimensions and floor plan differences consult your sales executive. All dimensions are + or - 50mm and floor plans are not shown to scale. The kitchen layout and furniture positions are for indicative purposes only. ♿ Wheelchair accessible design is available for this property type and may have features which differ from our standard apartment type. Please speak to a sales executive for further information and specification details. Apartments have openable windows either side of mullions. Please speak to your sales agent for clarification.

BLOCK D

# Sixth Floor

NORTH EAST

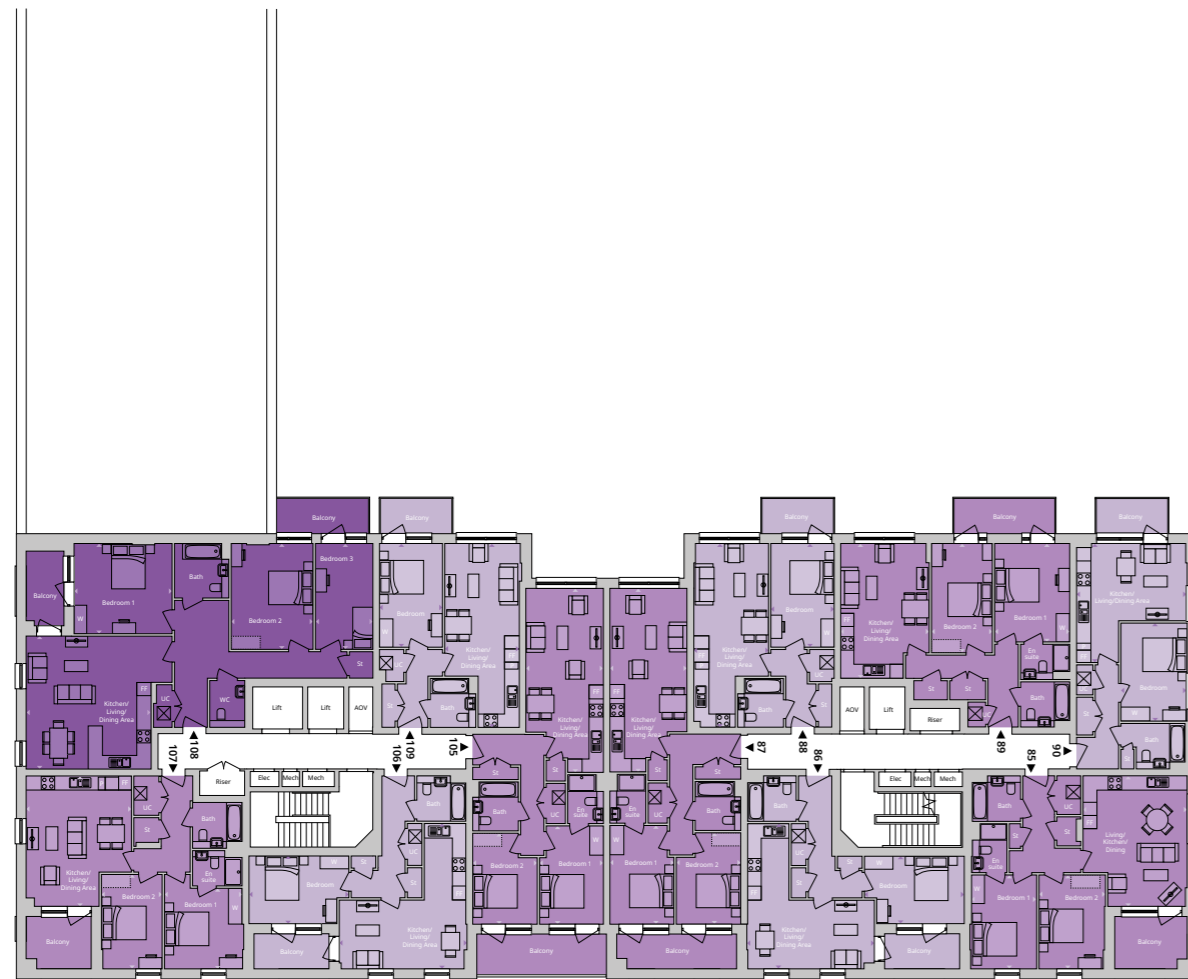
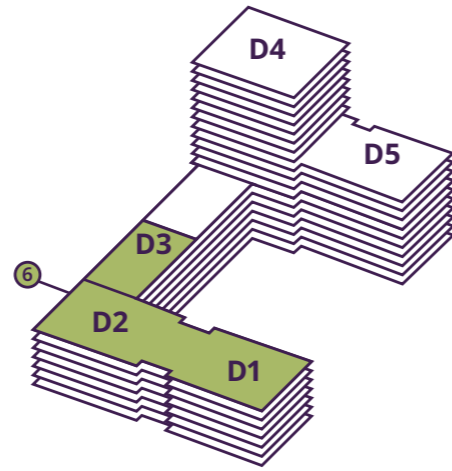

- 1 bedroom
- 2 bedroom
- 3 bedroom

- FF Fridge freezer
- P Pantry
- St Storage
- UC Utility cupboard
- W Wardrobe
- WC Washroom
- Indicative wardrobe space

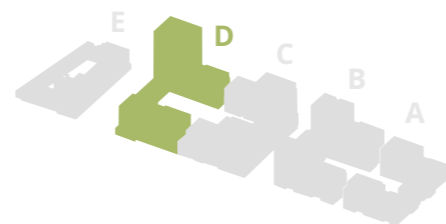

## 1 BED APARTMENTS

### Plot 86 Type CD08

**Kitchen/Living/Dining Area**  
6.50m max × 5.70m max 21'5" max × 18'9" max

**Bedroom**  
4.50m max × 3.10m max 14'9" max × 10'0" max

**Total: 54.90 sq m | 591 sq ft**

### Plot 88 Type CD06

**Kitchen/Living/Dining Area**  
8.25m max × 3.34m max 27'1" max × 10'11" max

**Bedroom**  
4.67m × 2.85m 15'4" × 9'4"

**Total: 51.10 sq m | 550 sq ft**

### Plot 90 Type CD04

**Kitchen/Living/Dining Area**  
5.40m max × 5.00m max 17'4" max × 16'4" max

**Bedroom**  
4.40m max × 3.00m max 14'6" max × 9'10" max

**Total: 50.60 sq m | 545 sq ft**

### Plot 106 Type CD08

**Kitchen/Living/Dining Area**  
6.50m max × 5.70m max 21'5" max × 18'9" max

**Bedroom**  
4.50m max × 3.10m max 14'9" max × 10'0" max

**Total: 54.90 sq m | 591 sq ft**

### Plot 109 Type CD06

**Kitchen/Living/Dining Area**  
8.25m max × 3.34m max 27'1" max × 10'11" max

**Bedroom**  
4.67m × 2.85m 15'4" × 9'4"

**Total: 51.10 sq m | 550 sq ft**

## 2 BED APARTMENTS

### Plot 85 Type CD33

**Kitchen/Living/Dining Area**  
5.90m max × 4.70m max 19'3" max × 15'5" max

**Bedroom 1**  
4.20m × 3.00m 13'11" × 9'9"

**Bedroom 2**  
4.20m × 2.80m 13'11" × 9'1"

**Total: 73.70 sq m | 793 sq ft**

### Plot 87 Type CD07

**Kitchen/Living/Dining Area**  
8.20m max × 3.60m max 27'0" max × 11'11" max

**Bedroom 1**  
4.40m max × 3.10m max 14'7" max × 10'11" max

**Bedroom 2**  
3.00m min × 2.90m max 9'10" min × 9'5" max

**Total: 72.80 sq m | 784 sq ft**

### Plot 89 Type CD34

**Kitchen/Living/Dining Area**  
6.10m max × 4.00m max 19'11" max × 13'1" max

**Bedroom 1**  
4.40m × 3.40m 14'6" × 11'1"

**Bedroom 2**  
4.90m × 2.80m 16'2" × 9'0"

**Total: 74.70 sq m | 804 sq ft**

### Plot 105 Type CD07

**Kitchen/Living/Dining Area**  
8.20m max × 3.60m max 27'0" max × 11'11" max

**Bedroom 1**  
4.40m max × 3.10m max 14'7" max × 10'11" max

**Bedroom 2**  
3.00m min × 2.90m max 9'10" min × 9'5" max

**Total: 72.80 sq m | 784 sq ft**

### Plot 107 Type CD17

**Kitchen/Living/Dining Area**  
5.90m max × 4.70m max 19'3" max × 15'7" max

**Bedroom 1**  
3.70m min × 3.50m max 12'0" min × 11'5" max

**Bedroom 2**  
4.30m max × 2.80m max 14'0" max × 9'1" max

**Total: 72.00 sq m | 775 sq ft**

## 3 BED APARTMENT

### Plot 108 Type CD13

**Kitchen/Living/Dining Area**  
6.60m max × 6.00m max 21'6" max × 19'7" max

**Bedroom 1**  
4.40m max × 4.10m max 14'4" max × 13'4" max

**Bedroom 2**  
4.80m max × 3.70m max 15'8" max × 12'2" max

**Bedroom 3**  
4.80m × 2.60m 15'8" × 8'5"

**Total: 118.20 sq m | 1,272 sq ft**

Floor plans depict a typical layout of this apartment type. For exact plot specification, details of external and internal finishes, dimensions and floor plan differences consult your sales executive. All dimensions are + or - 50mm and floor plans are not shown to scale. The kitchen layout and furniture positions are for indicative purposes only. Wheelchair accessible design is available for this property type and may have features which differ from our standard apartment type. Please speak to a sales executive for further information and specification details. Apartments have operable windows either side of mullions. Please speak to your sales agent for clarification.



BLOCK D

# Seventh Floor

NORTH WEST

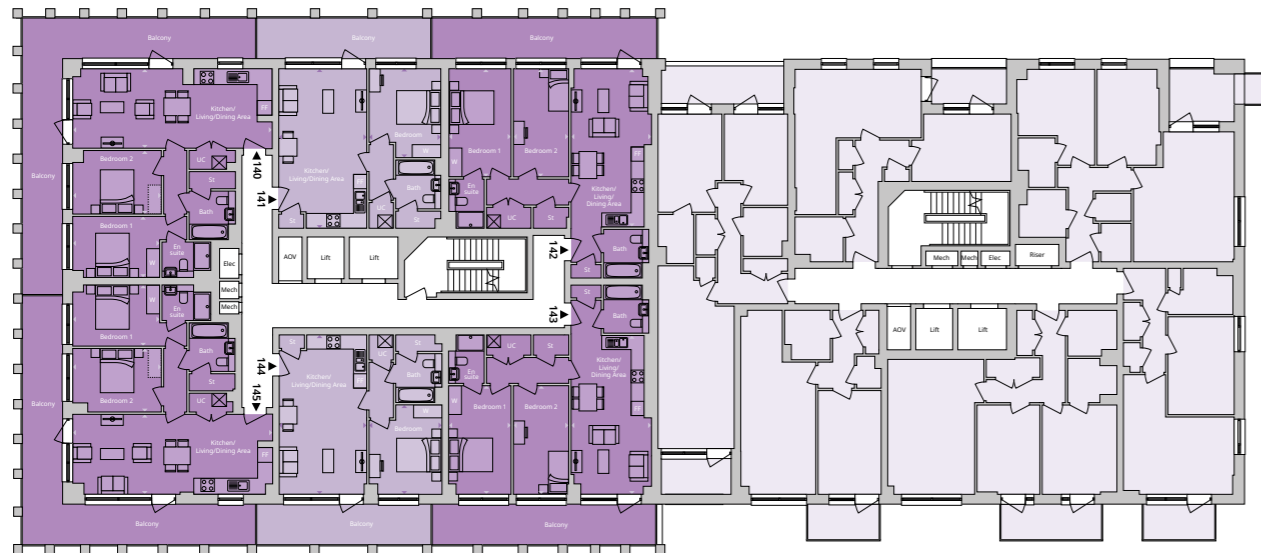
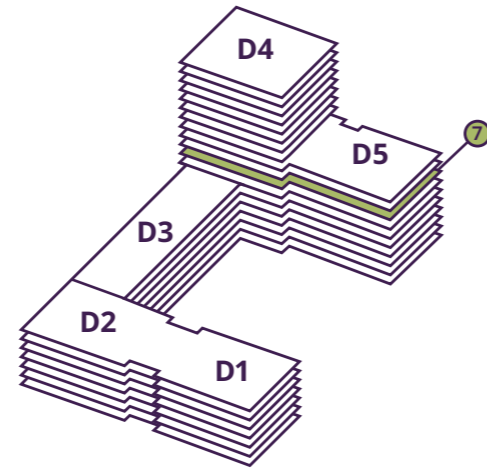

## 1 BED APARTMENTS

### Plot 144 Type CD02

**Kitchen/Living/Dining Area**  
7.20m max × 4.00m max 23'7" max × 13'0" max

**Bedroom**  
4.00m max × 3.30m max 13'2" max × 10'8" max

**Total: 52.60 sq m | 566 sq ft**

### Plot 141 Type CD02

**Kitchen/Living/Dining Area**  
7.20m max × 4.00m max 23'7" max × 13'0" max

**Bedroom**  
4.00m max × 3.30m max 13'2" max × 10'8" max

**Total: 52.60 sq m | 566 sq ft**

## 2 BED APARTMENTS

### Plot 140 Type CD01

**Kitchen/Living/Dining Area**  
8.90m max × 3.60m max 29'1" max × 11'10" max

**Bedroom 1**  
3.90m min × 2.80m max 12'10" min × 9'0" max

**Bedroom 2**  
4.00m × 2.90m 13'2" × 9'5"

**Total: 72.50 sq m | 780 sq ft**

### Plot 142 Type CD03

**Kitchen/Living/Dining Area**  
7.10m min × 3.60m max 23'4" min × 11'10" max

**Bedroom 1**  
4.90m max × 2.80m max 16'1" max × 9'11" max

**Bedroom 2**  
4.90m × 2.50m max 16'1" × 8'3" max

**Total: 73.50 sq m | 791 sq ft**

### Plot 143 Type CD03

**Kitchen/Living/Dining Area**  
7.10m min × 3.60m max 23'4" min × 11'10" max

**Bedroom 1**  
4.90m max × 2.80m max 16'1" max × 9'11" max

**Bedroom 2**  
4.90m × 2.50m max 16'1" × 8'3" max

**Total: 73.50 sq m | 791 sq ft**

### Plot 145 Type CD01

**Kitchen/Living/Dining Area**  
8.90m max × 3.60m max 29'1" max × 11'10" max

**Bedroom 1**  
3.90m min × 2.80m max 12'10" min × 9'0" max

**Bedroom 2**  
4.00m × 2.90m 13'2" × 9'5"

**Total: 72.50 sq m | 780 sq ft**

- 1 bedroom
- 2 bedroom
- Commercial area
- FF Fridge freezer
- St Storage
- UC Utility cupboard
- W Wardrobe
- Indicative wardrobe space

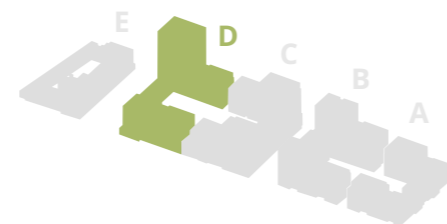

Floor plans depict a typical layout of this apartment type. For exact plot specification, details of external and internal finishes, dimensions and floor plan differences consult your sales executive. All dimensions are + or - 50mm and floor plans are not shown to scale. The kitchen layout and furniture positions are for indicative purposes only. ♿ Wheelchair accessible design is available for this property type and may have features which differ from our standard apartment type. Please speak to a sales executive for further information and specification details. Apartments have openable windows either side of mullions. Please speak to your sales agent for clarification.

BLOCK D

# Eighth Floor

NORTH WEST

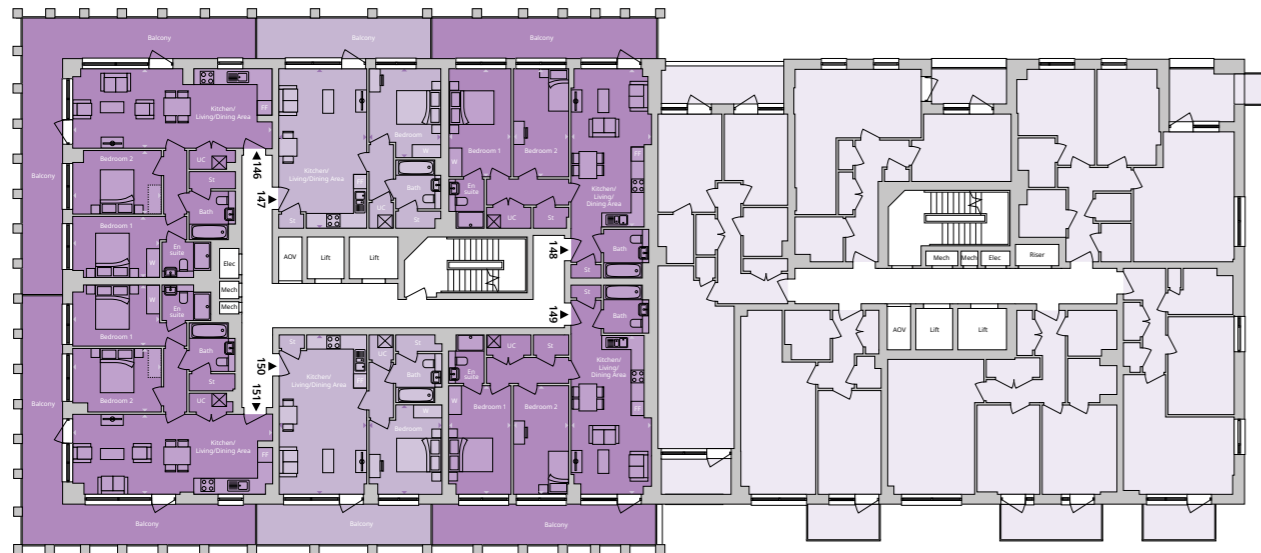
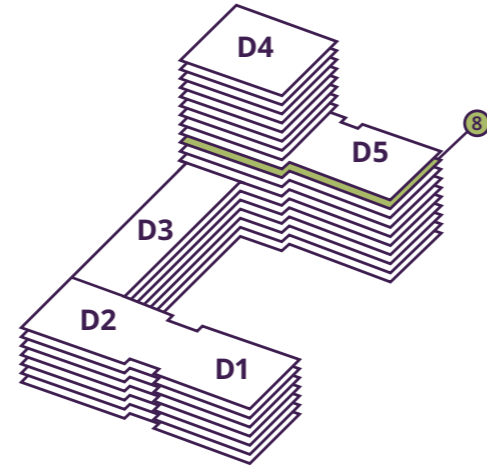

## 1 BED APARTMENTS

### Plot 147 Type CD02

**Kitchen/Living/Dining Area**  
7.20m max × 4.00m max 23'7" max × 13'0" max

**Bedroom**  
4.00m max × 3.30m max 13'2" max × 10'8" max

**Total: 52.60 sq m | 566 sq ft**

### Plot 150 Type CD02

**Kitchen/Living/Dining Area**  
7.20m max × 4.00m max 23'7" max × 13'0" max

**Bedroom**  
4.00m max × 3.30m max 13'2" max × 10'8" max

**Total: 52.60 sq m | 566 sq ft**

## 2 BED APARTMENTS

### Plot 146 Type CD01

**Kitchen/Living/Dining Area**  
8.90m max × 3.60m max 29'1" max × 11'10" max

**Bedroom 1**  
3.90m min × 2.80m max 12'10" min × 9'0" max

**Bedroom 2**  
4.00m × 2.90m 13'2" × 9'5"

**Total: 72.50 sq m | 780 sq ft**

### Plot 148 Type CD03

**Kitchen/Living/Dining Area**  
7.10m min × 3.60m max 23'4" min × 11'10" max

**Bedroom 1**  
4.90m max × 2.80m max 16'1" max × 9'11" max

**Bedroom 2**  
4.90m × 2.50m max 16'1" × 8'3" max

**Total: 73.50 sq m | 791 sq ft**

### Plot 149 Type CD03

**Kitchen/Living/Dining Area**  
7.10m min × 3.60m max 23'4" min × 11'10" max

**Bedroom 1**  
4.90m max × 2.80m max 16'1" max × 9'11" max

**Bedroom 2**  
4.90m × 2.50m max 16'1" × 8'3" max

**Total: 73.50 sq m | 791 sq ft**

### Plot 151 Type CD01

**Kitchen/Living/Dining Area**  
8.90m max × 3.60m max 29'1" max × 11'10" max

**Bedroom 1**  
3.90m min × 2.80m max 12'10" min × 9'0" max

**Bedroom 2**  
4.00m × 2.90m 13'2" × 9'5"

**Total: 72.50 sq m | 780 sq ft**

- 1 bedroom
- 2 bedroom
- 3 bedroom
- Affordable housing
- Commercial area
- FF Fridge freezer
- St Storage
- UC Utility cupboard
- W Wardrobe
- Indicative wardrobe space

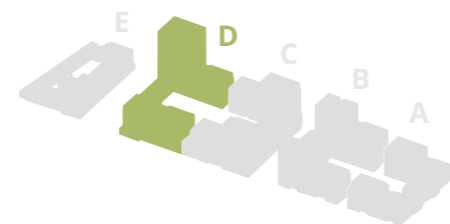

Floor plans depict a typical layout of this apartment type. For exact plot specification, details of external and internal finishes, dimensions and floor plan differences consult your sales executive. All dimensions are + or - 50mm and floor plans are not shown to scale. The kitchen layout and furniture positions are for indicative purposes only. ♿ Wheelchair accessible design is available for this property type and may have features which differ from our standard apartment type. Please speak to a sales executive for further information and specification details. Apartments have openable windows either side of mullions. Please speak to your sales agent for clarification.

BLOCK D

# Ninth Floor

NORTH WEST

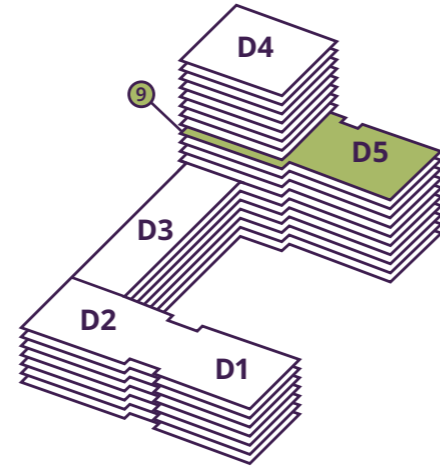

## 1 BED APARTMENTS

### Plot 153 Type CD02

**Kitchen/Living/Dining Area**  
7.20m max × 4.00m max 23'7" max × 13'0" max

**Bedroom**  
4.00m max × 3.30m max 13'2" max × 10'8" max

**Total: 52.60 sq m | 566 sq ft**

### Plot 156 Type CD02

**Kitchen/Living/Dining Area**  
7.20m max × 4.00m max 23'7" max × 13'0" max

**Bedroom**  
4.00m max × 3.30m max 13'2" max × 10'8" max

**Total: 52.60 sq m | 566 sq ft**

## 2 BED APARTMENTS

### Plot 152 Type CD01

**Kitchen/Living/Dining Area**  
8.90m max × 3.60m max 29'1" max × 11'10" max

**Bedroom 1**  
3.90m min × 2.80m max 12'10" min × 9'0" max

**Bedroom 2**  
4.00m × 2.90m 13'2" × 9'5"

**Total: 72.50 sq m | 780 sq ft**

### Plot 154 Type CD03

**Kitchen/Living/Dining Area**  
7.10m min × 3.60m max 23'4" min × 11'10" max

**Bedroom 1**  
4.90m max × 2.80m max 16'1" max × 9'11" max

**Bedroom 2**  
4.90m × 2.50m max 16'1" × 8'3" max

**Total: 73.50 sq m | 791 sq ft**

### Plot 155 Type CD03

**Kitchen/Living/Dining Area**  
7.10m min × 3.60m max 23'4" min × 11'10" max

**Bedroom 1**  
4.90m max × 2.80m max 16'1" max × 9'11" max

**Bedroom 2**  
4.90m × 2.50m max 16'1" × 8'3" max

**Total: 73.50 sq m | 791 sq ft**

### Plot 157 Type CD01

**Kitchen/Living/Dining Area**  
8.90m max × 3.60m max 29'1" max × 11'10" max

**Bedroom 1**  
3.90m min × 2.80m max 12'10" min × 9'0" max

**Bedroom 2**  
4.00m × 2.90m 13'2" × 9'5"

**Total: 72.50 sq m | 780 sq ft**

- FF Fridge freezer
- St Storage
- UC Utility cupboard
- W Wardrobe
- Indicative wardrobe space

- 1 bedroom
- 2 bedroom

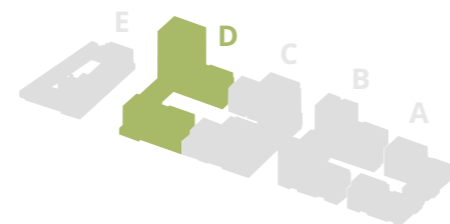

Floor plans depict a typical layout of this apartment type. For exact plot specification, details of external and internal finishes, dimensions and floor plan differences consult your sales executive. All dimensions are + or - 50mm and floor plans are not shown to scale. The kitchen layout and furniture positions are for indicative purposes only. ♿ Wheelchair accessible design is available for this property type and may have features which differ from our standard apartment type. Please speak to a sales executive for further information and specification details. Apartments have openable windows either side of mullions. Please speak to your sales agent for clarification.

BLOCK D

# Tenth Floor

NORTH WEST

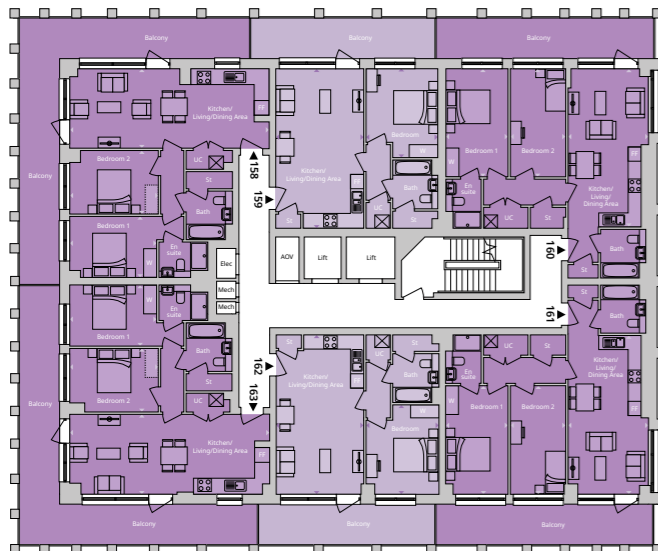
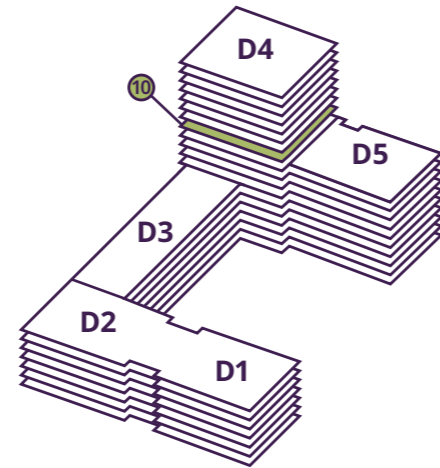

- 1 bedroom
- 2 bedroom

- FF Fridge freezer
- St Storage
- UC Utility cupboard
- W Wardrobe
- Indicative wardrobe space

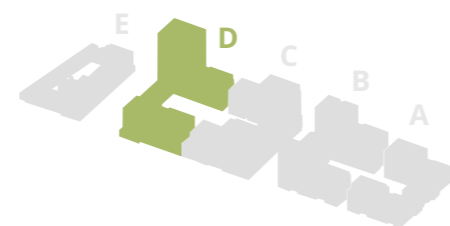

## 1 BED APARTMENTS

### Plot 159 Type CD02

**Kitchen/Living/Dining Area**  
7.20m max × 4.00m max 23'7" max × 13'0" max

**Bedroom**  
4.00m max × 3.30m max 13'2" max × 10'8" max

**Total: 52.60 sq m | 566 sq ft**

### Plot 162 Type CD02

**Kitchen/Living/Dining Area**  
7.20m max × 4.00m max 23'7" max × 13'0" max

**Bedroom**  
4.00m max × 3.30m max 13'2" max × 10'8" max

**Total: 52.50 sq m | 566 sq ft**

## 2 BED APARTMENTS

### Plot 158 Type CD01

**Kitchen/Living/Dining Area**  
8.90m max × 3.60m max 29'1" max × 11'10" max

**Bedroom 1**  
3.90m min × 2.80m max 12'10" min × 9'0" max

**Bedroom 2**  
4.00m × 2.90m 13'2" × 9'5"

**Total: 72.50 sq m | 780 sq ft**

### Plot 160 Type CD03

**Kitchen/Living/Dining Area**  
7.10m min × 3.60m max 23'4" min × 11'10" max

**Bedroom 1**  
4.90m max × 2.80m max 16'1" max × 9'11" max

**Bedroom 2**  
4.90m × 2.50m max 16'1" × 8'3" max

**Total: 73.50 sq m | 791 sq ft**

### Plot 161 Type CD03

**Kitchen/Living/Dining Area**  
7.10m min × 3.60m max 23'4" min × 11'10" max

**Bedroom 1**  
4.90m max × 2.80m max 16'1" max × 9'11" max

**Bedroom 2**  
4.90m × 2.50m max 16'1" × 8'3" max

**Total: 73.50 sq m | 791 sq ft**

### Plot 163 Type CD01

**Kitchen/Living/Dining Area**  
8.90m max × 3.60m max 29'1" max × 11'10" max

**Bedroom 1**  
3.90m min × 2.80m max 12'10" min × 9'0" max

**Bedroom 2**  
4.00m × 2.90m 13'2" × 9'5"

**Total: 72.50 sq m | 780 sq ft**

Floor plans depict a typical layout of this apartment type. For exact plot specification, details of external and internal finishes, dimensions and floor plan differences consult your sales executive. All dimensions are + or - 50mm and floor plans are not shown to scale. The kitchen layout and furniture positions are for indicative purposes only. ♿ Wheelchair accessible design is available for this property type and may have features which differ from our standard apartment type. Please speak to a sales executive for further information and specification details. Apartments have openable windows either side of mullions. Please speak to your sales agent for clarification.

BLOCK D

# Eleventh Floor

NORTH WEST

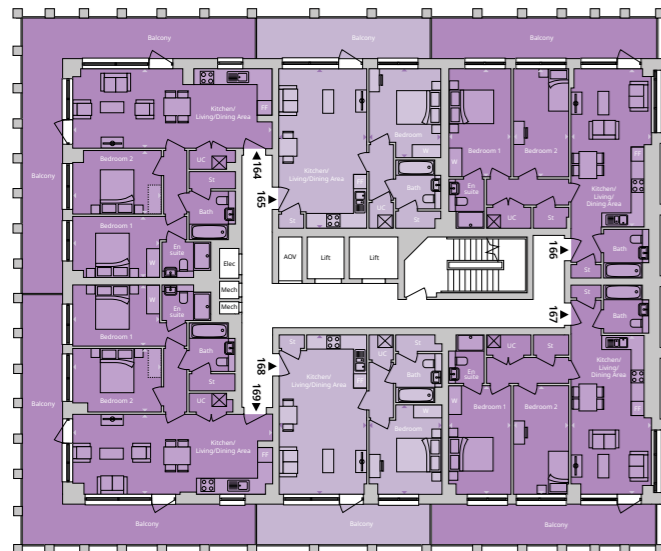
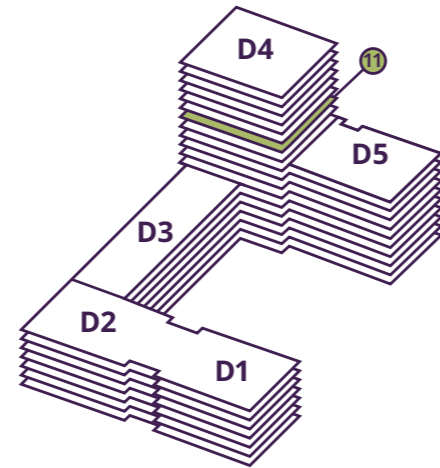

- 1 bedroom
- 2 bedroom

- FF Fridge freezer
- St Storage
- UC Utility cupboard
- W Wardrobe
- Indicative wardrobe space

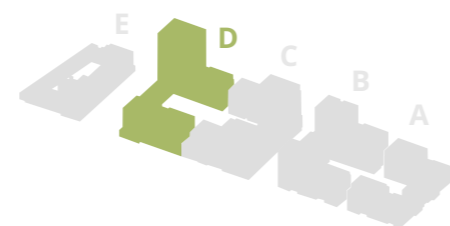

## 1 BED APARTMENTS

### Plot 165 Type CD02

**Kitchen/Living/Dining Area**  
7.20m max × 4.00m max 23'7" max × 13'0" max

**Bedroom**  
4.00m max × 3.30m max 13'2" max × 10'8" max

**Total: 52.60 sq m | 566 sq ft**

### Plot 168 Type CD02

**Kitchen/Living/Dining Area**  
7.20m max × 4.00m max 23'7" max × 13'0" max

**Bedroom**  
4.00m max × 3.30m max 13'2" max × 10'8" max

**Total: 52.60 sq m | 566 sq ft**

## 2 BED APARTMENTS

### Plot 164 Type CD01

**Kitchen/Living/Dining Area**  
8.90m max × 3.60m max 29'1" max × 11'10" max

**Bedroom 1**  
3.90m min × 2.80m max 12'10" min × 9'0" max

**Bedroom 2**  
4.00m × 2.90m 13'2" × 9'5"

**Total: 72.50 sq m | 780 sq ft**

### Plot 166 Type CD03

**Kitchen/Living/Dining Area**  
7.10m min × 3.60m max 23'4" min × 11'10" max

**Bedroom 1**  
4.90m max × 2.80m max 16'1" max × 9'11" max

**Bedroom 2**  
4.90m × 2.50m max 16'1" × 8'3" max

**Total: 73.50 sq m | 791 sq ft**

### Plot 167 Type CD03

**Kitchen/Living/Dining Area**  
7.10m min × 3.60m max 23'4" min × 11'10" max

**Bedroom 1**  
4.90m max × 2.80m max 16'1" max × 9'11" max

**Bedroom 2**  
4.90m × 2.50m max 16'1" × 8'3" max

**Total: 73.50 sq m | 791 sq ft**

### Plot 169 Type CD01

**Kitchen/Living/Dining Area**  
8.90m max × 3.60m max 29'1" max × 11'10" max

**Bedroom 1**  
3.90m min × 2.80m max 12'10" min × 9'0" max

**Bedroom 2**  
4.00m × 2.90m 13'2" × 9'5"

**Total: 72.50 sq m | 780 sq ft**

Floor plans depict a typical layout of this apartment type. For exact plot specification, details of external and internal finishes, dimensions and floor plan differences consult your sales executive. All dimensions are + or - 50mm and floor plans are not shown to scale. The kitchen layout and furniture positions are for indicative purposes only. ♿ Wheelchair accessible design is available for this property type and may have features which differ from our standard apartment type. Please speak to a sales executive for further information and specification details. Apartments have openable windows either side of mullions. Please speak to your sales agent for clarification.

BLOCK D

# Twelfth Floor

NORTH WEST

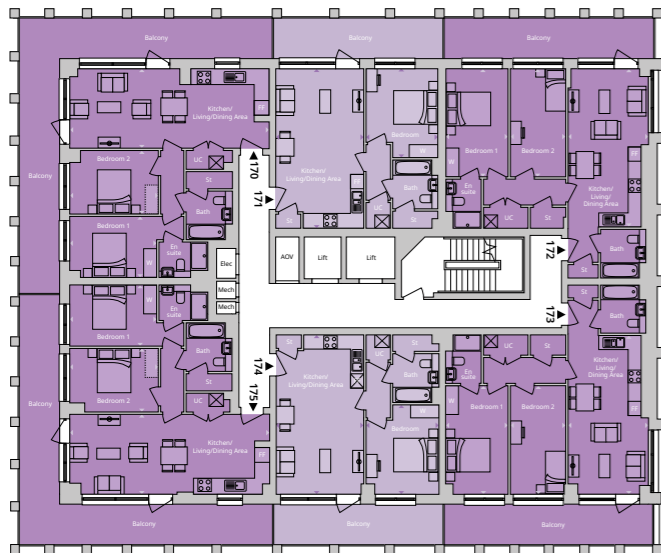
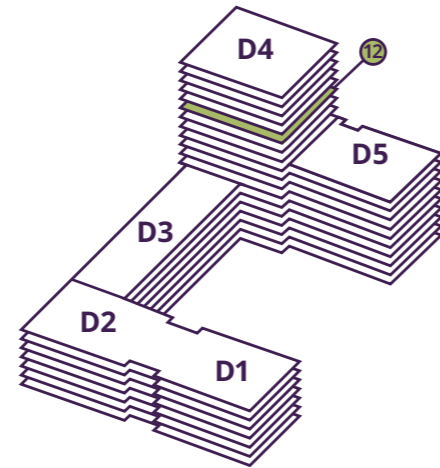

- 1 bedroom
- 2 bedroom

- FF Fridge freezer
- St Storage
- UC Utility cupboard
- W Wardrobe
- Indicative wardrobe space

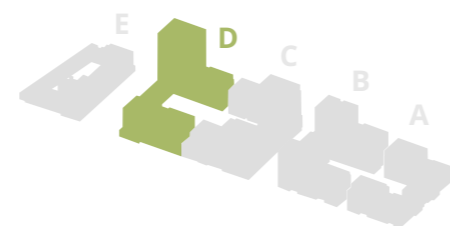

## 1 BED APARTMENTS

### Plot 171 Type CD02

**Kitchen/Living/Dining Area**  
7.20m max × 4.00m max 23'7" max × 13'0" max

**Bedroom**  
4.00m max × 3.30m max 13'2" max × 10'8" max

**Total: 52.60 sq m | 566 sq ft**

### Plot 174 Type CD02

**Kitchen/Living/Dining Area**  
7.20m max × 4.00m max 23'7" max × 13'0" max

**Bedroom**  
4.00m max × 3.30m max 13'2" max × 10'8" max

**Total: 52.60 sq m | 566 sq ft**

## 2 BED APARTMENTS

### Plot 170 Type CD01

**Kitchen/Living/Dining Area**  
8.90m max × 3.60m max 29'1" max × 11'10" max

**Bedroom 1**  
3.90m min × 2.80m max 12'10" min × 9'0" max

**Bedroom 2**  
4.00m × 2.90m 13'2" × 9'5"

**Total: 72.50 sq m | 780 sq ft**

### Plot 172 Type CD03

**Kitchen/Living/Dining Area**  
7.10m min × 3.60m max 23'4" min × 11'10" max

**Bedroom 1**  
4.90m max × 2.80m max 16'1" max × 9'11" max

**Bedroom 2**  
4.90m × 2.50m max 16'1" × 8'3" max

**Total: 73.50 sq m | 791 sq ft**

### Plot 173 Type CD03

**Kitchen/Living/Dining Area**  
7.10m min × 3.60m max 23'4" min × 11'10" max

**Bedroom 1**  
4.90m max × 2.80m max 16'1" max × 9'11" max

**Bedroom 2**  
4.90m × 2.50m max 16'1" × 8'3" max

**Total: 73.50 sq m | 791 sq ft**

### Plot 175 Type CD01

**Kitchen/Living/Dining Area**  
8.90m max × 3.60m max 29'1" max × 11'10" max

**Bedroom 1**  
3.90m min × 2.80m max 12'10" min × 9'0" max

**Bedroom 2**  
4.00m × 2.90m 13'2" × 9'5"

**Total: 72.50 sq m | 780 sq ft**

Floor plans depict a typical layout of this apartment type. For exact plot specification, details of external and internal finishes, dimensions and floor plan differences consult your sales executive. All dimensions are + or - 50mm and floor plans are not shown to scale. The kitchen layout and furniture positions are for indicative purposes only. ♿ Wheelchair accessible design is available for this property type and may have features which differ from our standard apartment type. Please speak to a sales executive for further information and specification details. Apartments have openable windows either side of mullions. Please speak to your sales agent for clarification.

BLOCK D

# Thirteenth Floor

NORTH WEST

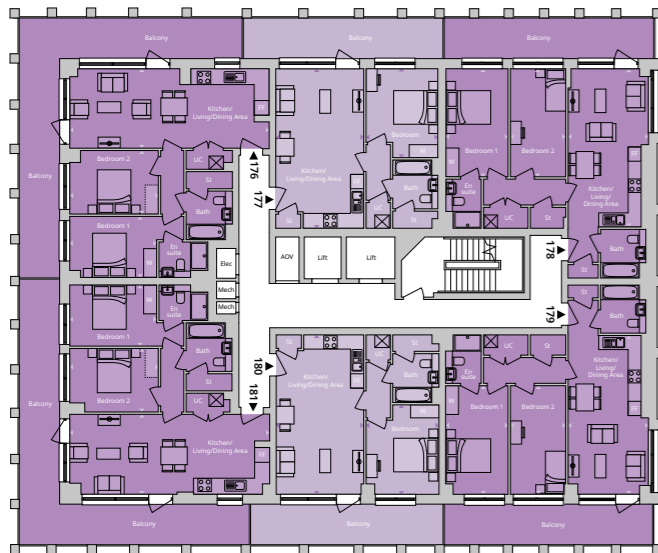
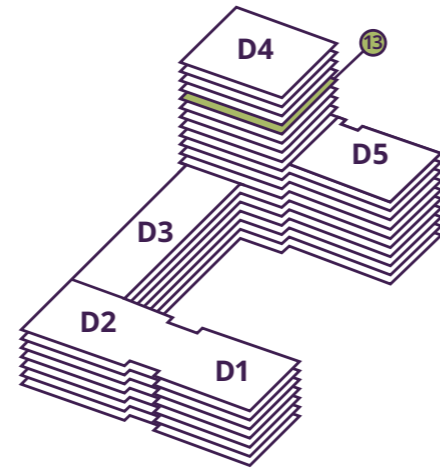

- 1 bedroom
- 2 bedroom

- FF Fridge freezer
- St Storage
- UC Utility cupboard
- W Wardrobe
- Indicative wardrobe space

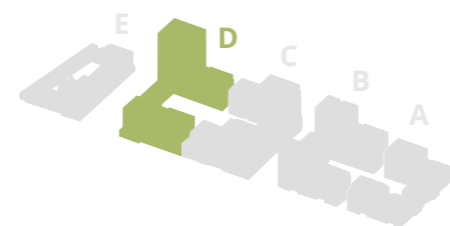

## 1 BED APARTMENTS

### Plot 177 Type CD02

**Kitchen/Living/Dining Area**  
7.20m max × 4.00m max 23'7" max × 13'0" max

**Bedroom**  
4.00m max × 3.30m max 13'2" max × 10'8" max

**Total: 52.60 sq m | 566 sq ft**

### Plot 180 Type CD02

**Kitchen/Living/Dining Area**  
7.20m max × 4.00m max 23'7" max × 13'0" max

**Bedroom**  
4.00m max × 3.30m max 13'2" max × 10'8" max

**Total: 52.60 sq m | 566 sq ft**

## 2 BED APARTMENTS

### Plot 176 Type CD01

**Kitchen/Living/Dining Area**  
8.90m max × 3.60m max 29'1" max × 11'10" max

**Bedroom 1**  
3.90m min × 2.80m max 12'10" min × 9'0" max

**Bedroom 2**  
4.00m × 2.90m 13'2" × 9'5"

**Total: 72.50 sq m | 780 sq ft**

### Plot 178 Type CD03

**Kitchen/Living/Dining Area**  
7.10m min × 3.60m max 23'4" min × 11'10" max

**Bedroom 1**  
4.90m max × 2.80m max 16'1" max × 9'11" max

**Bedroom 2**  
4.90m × 2.50m max 16'1" × 8'3" max

**Total: 73.50 sq m | 791 sq ft**

### Plot 179 Type CD03

**Kitchen/Living/Dining Area**  
7.10m min × 3.60m max 23'4" min × 11'10" max

**Bedroom 1**  
4.90m max × 2.80m max 16'1" max × 9'11" max

**Bedroom 2**  
4.90m × 2.50m max 16'1" × 8'3" max

**Total: 73.50 sq m | 791 sq ft**

### Plot 181 Type CD01

**Kitchen/Living/Dining Area**  
8.90m max × 3.60m max 29'1" max × 11'10" max

**Bedroom 1**  
3.90m min × 2.80m max 12'10" min × 9'0" max

**Bedroom 2**  
4.00m × 2.90m 13'2" × 9'5"

**Total: 72.50 sq m | 780 sq ft**

Floor plans depict a typical layout of this apartment type. For exact plot specification, details of external and internal finishes, dimensions and floor plan differences consult your sales executive. All dimensions are + or - 50mm and floor plans are not shown to scale. The kitchen layout and furniture positions are for indicative purposes only. ♿ Wheelchair accessible design is available for this property type and may have features which differ from our standard apartment type. Please speak to a sales executive for further information and specification details. Apartments have openable windows either side of mullions. Please speak to your sales agent for clarification.

BLOCK D

# Fourteenth Floor

NORTH WEST

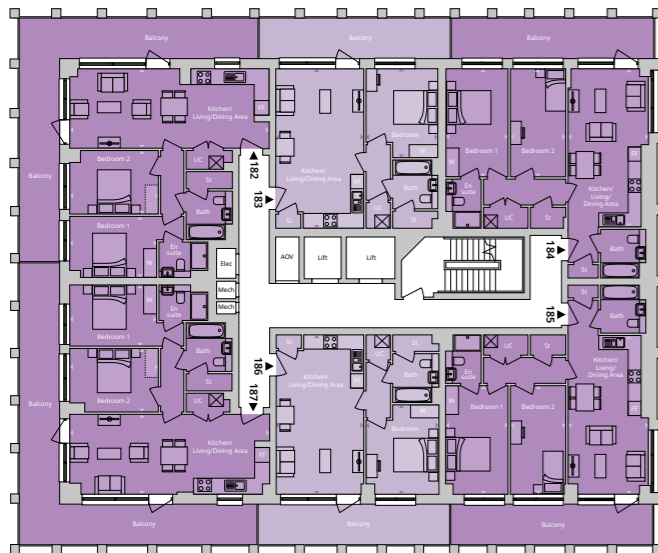
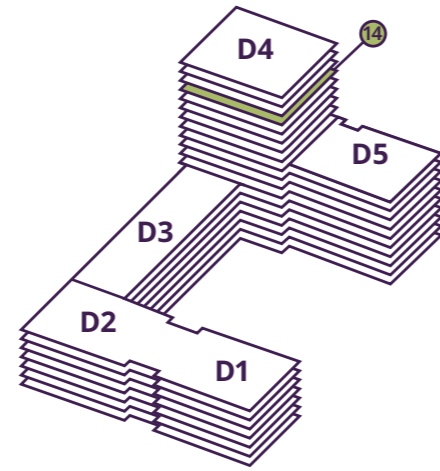

- 1 bedroom
- 2 bedroom

- FF Fridge freezer
- St Storage
- UC Utility cupboard
- W Wardrobe
- Indicative wardrobe space

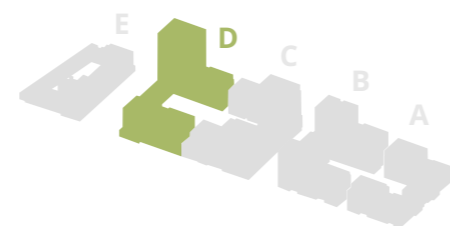

## 1 BED APARTMENTS

### Plot 183 Type CD02

Kitchen/Living/Dining Area  
7.20m max × 4.00m max 23'7" max × 13'0" max

Bedroom  
4.00m max × 3.30m max 13'2" max × 10'8" max

Total: 52.60 sq m | 566 sq ft

### Plot 186 Type CD02

Kitchen/Living/Dining Area  
7.20m max × 4.00m max 23'7" max × 13'0" max

Bedroom  
4.00m max × 3.30m max 13'2" max × 10'8" max

Total: 52.60 sq m | 566 sq ft

## 2 BED APARTMENTS

### Plot 182 Type CD01

Kitchen/Living/Dining Area  
8.90m max × 3.60m max 29'1" max × 11'10" max

Bedroom 1  
3.90m min × 2.80m max 12'10" min × 9'0" max

Bedroom 2  
4.00m × 2.90m 13'2" × 9'5"

Total: 72.50 sq m | 780 sq ft

### Plot 184 Type CD03

Kitchen/Living/Dining Area  
7.10m min × 3.60m max 23'4" min × 11'10" max

Bedroom 1  
4.90m max × 2.80m max 16'1" max × 9'11" max

Bedroom 2  
4.90m × 2.50m max 16'1" × 8'3" max

Total: 73.50 sq m | 791 sq ft

### Plot 185 Type CD03

Kitchen/Living/Dining Area  
7.10m min × 3.60m max 23'4" min × 11'10" max

Bedroom 1  
4.90m max × 2.80m max 16'1" max × 9'11" max

Bedroom 2  
4.90m × 2.50m max 16'1" × 8'3" max

Total: 73.50 sq m | 791 sq ft

### Plot 187 Type CD01

Kitchen/Living/Dining Area  
8.90m max × 3.60m max 29'1" max × 11'10" max

Bedroom 1  
3.90m min × 2.80m max 12'10" min × 9'0" max

Bedroom 2  
4.00m × 2.90m 13'2" × 9'5"

Total: 72.50 sq m | 780 sq ft

Floor plans depict a typical layout of this apartment type. For exact plot specification, details of external and internal finishes, dimensions and floor plan differences consult your sales executive. All dimensions are + or - 50mm and floor plans are not shown to scale. The kitchen layout and furniture positions are for indicative purposes only. ♿ Wheelchair accessible design is available for this property type and may have features which differ from our standard apartment type. Please speak to a sales executive for further information and specification details. Apartments have openable windows either side of mullions. Please speak to your sales agent for clarification.



BLOCK D

# Fifteenth Floor

NORTH WEST

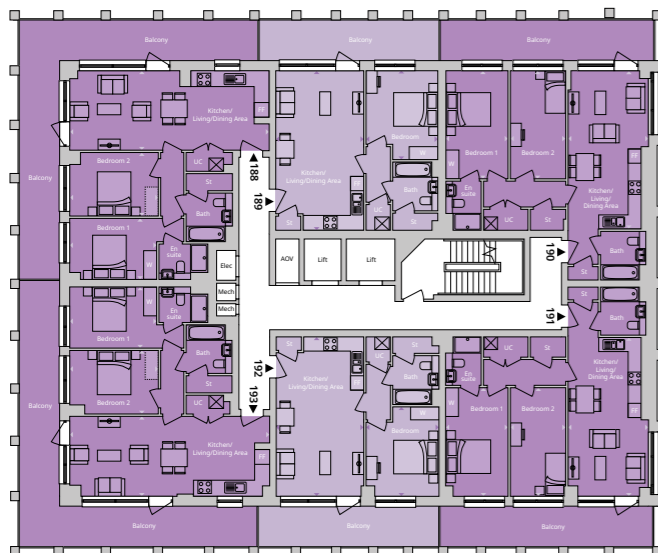
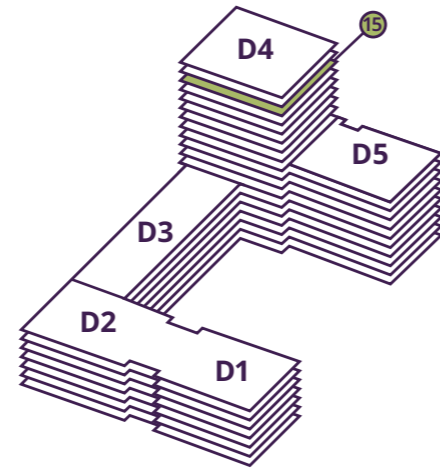

## 1 BED APARTMENTS

### Plot 189 Type CD02

**Kitchen/Living/Dining Area**  
7.20m max × 4.00m max 23'7" max × 13'0" max

**Bedroom**  
4.00m max × 3.30m max 13'2" max × 10'8" max

**Total: 52.60 sq m | 566 sq ft**

### Plot 192 Type CD02

**Kitchen/Living/Dining Area**  
7.20m max × 4.00m max 23'7" max × 13'0" max

**Bedroom**  
4.00m max × 3.30m max 13'2" max × 10'8" max

**Total: 52.60 sq m | 566 sq ft**

## 2 BED APARTMENTS

### Plot 188 Type CD01

**Kitchen/Living/Dining Area**  
8.90m max × 3.60m max 29'1" max × 11'10" max

**Bedroom 1**  
3.90m min × 2.80m max 12'10" min × 9'0" max

**Bedroom 2**  
4.00m × 2.90m 13'2" × 9'5"

**Total: 72.50 sq m | 780 sq ft**

### Plot 190 Type CD03

**Kitchen/Living/Dining Area**  
7.10m min × 3.60m max 23'4" min × 11'10" max

**Bedroom 1**  
4.90m max × 2.80m max 16'1" max × 9'11" max

**Bedroom 2**  
4.90m × 2.50m max 16'1" × 8'3" max

**Total: 73.50 sq m | 791 sq ft**

### Plot 191 Type CD03

**Kitchen/Living/Dining Area**  
7.10m min × 3.60m max 23'4" min × 11'10" max

**Bedroom 1**  
4.90m max × 2.80m max 16'1" max × 9'11" max

**Bedroom 2**  
4.90m × 2.50m max 16'1" × 8'3" max

**Total: 73.50 sq m | 791 sq ft**

### Plot 193 Type CD01

**Kitchen/Living/Dining Area**  
8.90m max × 3.60m max 29'1" max × 11'10" max

**Bedroom 1**  
3.90m min × 2.80m max 12'10" min × 9'0" max

**Bedroom 2**  
4.00m × 2.90m 13'2" × 9'5"

**Total: 72.50 sq m | 780 sq ft**

- FF Fridge freezer
- St Storage
- UC Utility cupboard
- W Wardrobe
- Indicative wardrobe space

- 1 bedroom
- 2 bedroom

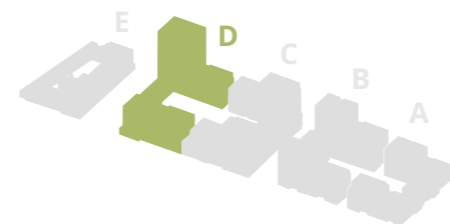

Floor plans depict a typical layout of this apartment type. For exact plot specification, details of external and internal finishes, dimensions and floor plan differences consult your sales executive. All dimensions are + or - 50mm and floor plans are not shown to scale. The kitchen layout and furniture positions are for indicative purposes only. ♿ Wheelchair accessible design is available for this property type and may have features which differ from our standard apartment type. Please speak to a sales executive for further information and specification details. Apartments have openable windows either side of mullions. Please speak to your sales agent for clarification.

BLOCK D

# Sixteenth Floor

NORTH WEST

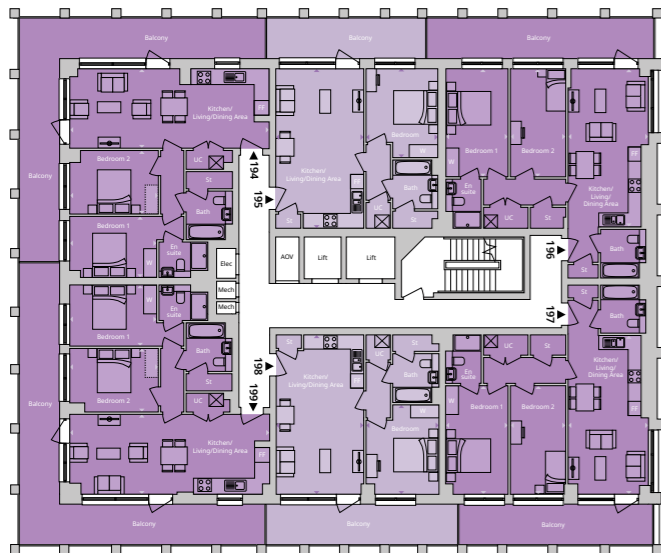
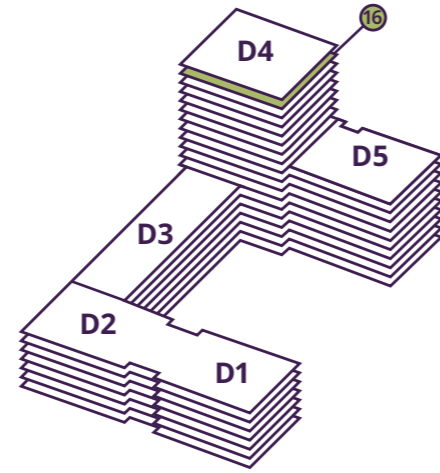

## 1 BED APARTMENTS

### Plot 195 Type CD02

**Kitchen/Living/Dining Area**  
7.20m max × 4.00m max 23'7" max × 13'0" max

**Bedroom**  
4.00m max × 3.30m max 13'2" max × 10'8" max

**Total: 52.60 sq m | 566 sq ft**

### Plot 198 Type CD02

**Kitchen/Living/Dining Area**  
7.20m max × 4.00m max 23'7" max × 13'0" max

**Bedroom**  
4.00m max × 3.30m max 13'2" max × 10'8" max

**Total: 52.60 sq m | 566 sq ft**

## 2 BED APARTMENTS

### Plot 194 Type CD01

**Kitchen/Living/Dining Area**  
8.90m max × 3.60m max 29'1" max × 11'10" max

**Bedroom 1**  
3.90m min × 2.80m max 12'10" min × 9'0" max

**Bedroom 2**  
4.00m × 2.90m 13'2" × 9'5"

**Total: 72.50 sq m | 780 sq ft**

### Plot 196 Type CD03

**Kitchen/Living/Dining Area**  
7.10m min × 3.60m max 23'4" min × 11'10" max

**Bedroom 1**  
4.90m max × 2.80m max 16'1" max × 9'11" max

**Bedroom 2**  
4.90m × 2.50m max 16'1" × 8'3" max

**Total: 73.50 sq m | 791 sq ft**

### Plot 197 Type CD03

**Kitchen/Living/Dining Area**  
7.10m min × 3.60m max 23'4" min × 11'10" max

**Bedroom 1**  
4.90m max × 2.80m max 16'1" max × 9'11" max

**Bedroom 2**  
4.90m × 2.50m max 16'1" × 8'3" max

**Total: 73.50 sq m | 791 sq ft**

### Plot 199 Type CD01

**Kitchen/Living/Dining Area**  
8.90m max × 3.60m max 29'1" max × 11'10" max

**Bedroom 1**  
3.90m min × 2.80m max 12'10" min × 9'0" max

**Bedroom 2**  
4.00m × 2.90m 13'2" × 9'5"

**Total: 72.50 sq m | 780 sq ft**

- FF Fridge freezer
- St Storage
- UC Utility cupboard
- W Wardrobe
- Indicative wardrobe space

- 1 bedroom
- 2 bedroom

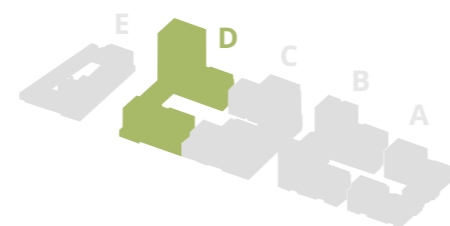

Floor plans depict a typical layout of this apartment type. For exact plot specification, details of external and internal finishes, dimensions and floor plan differences consult your sales executive. All dimensions are + or - 50mm and floor plans are not shown to scale. The kitchen layout and furniture positions are for indicative purposes only. ♿ Wheelchair accessible design is available for this property type and may have features which differ from our standard apartment type. Please speak to a sales executive for further information and specification details. Apartments have openable windows either side of mullions. Please speak to your sales agent for clarification.

BLOCK D

# Seventeenth Floor

NORTH WEST

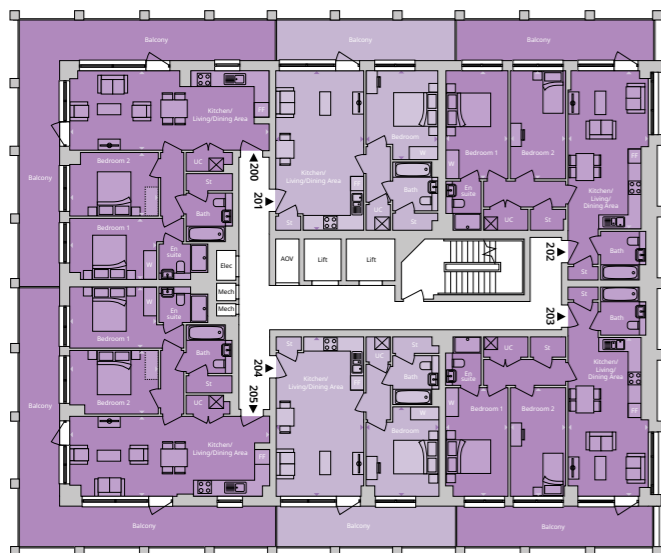
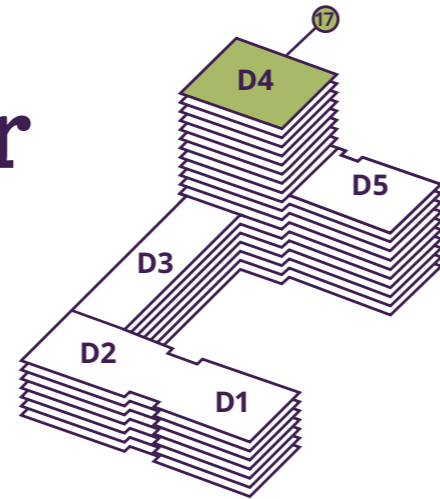

## 1 BED APARTMENTS

### Plot 201 Type CD02

**Kitchen/Living/Dining Area**  
7.20m max × 4.00m max 23'7" max × 13'0" max

**Bedroom**  
4.00m max × 3.30m max 13'2" max × 10'8" max

**Total: 52.60 sq m | 566 sq ft**

### Plot 204 Type CD02

**Kitchen/Living/Dining Area**  
7.20m max × 4.00m max 23'7" max × 13'0" max

**Bedroom**  
4.00m max × 3.30m max 13'2" max × 10'8" max

**Total: 52.60 sq m | 566 sq ft**

## 2 BED APARTMENTS

### Plot 200 Type CD01

**Kitchen/Living/Dining Area**  
8.90m max × 3.60m max 29'1" max × 11'10" max

**Bedroom 1**  
3.90m min × 2.80m max 12'10" min × 9'0" max

**Bedroom 2**  
4.00m × 2.90m 13'2" × 9'5"

**Total: 72.50 sq m | 780 sq ft**

### Plot 202 Type CD03

**Kitchen/Living/Dining Area**  
7.10m min × 3.60m max 23'4" min × 11'10" max

**Bedroom 1**  
4.90m max × 2.80m max 16'1" max × 9'11" max

**Bedroom 2**  
4.90m × 2.50m max 16'1" × 8'3" max

**Total: 72.50 sq m | 791 sq ft**

### Plot 203 Type CD03

**Kitchen/Living/Dining Area**  
7.10m min × 3.60m max 23'4" min × 11'10" max

**Bedroom 1**  
4.90m max × 2.80m max 16'1" max × 9'11" max

**Bedroom 2**  
4.90m × 2.50m max 16'1" × 8'3" max

**Total: 73.50 sq m | 791 sq ft**

### Plot 205 Type CD01

**Kitchen/Living/Dining Area**  
8.90m max × 3.60m max 29'1" max × 11'10" max

**Bedroom 1**  
3.90m min × 2.80m max 12'10" min × 9'0" max

**Bedroom 2**  
4.00m × 2.90m 13'2" × 9'5"

**Total: 72.50 sq m | 780 sq ft**

- 1 bedroom
- 2 bedroom

- FF Fridge freezer
- St Storage
- UC Utility cupboard
- W Wardrobe
- Indicative wardrobe space

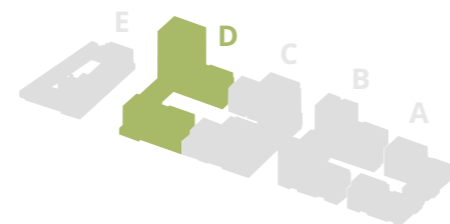

Floor plans depict a typical layout of this apartment type. For exact plot specification, details of external and internal finishes, dimensions and floor plan differences consult your sales executive. All dimensions are + or - 50mm and floor plans are not shown to scale. The kitchen layout and furniture positions are for indicative purposes only. ♿ Wheelchair accessible design is available for this property type and may have features which differ from our standard apartment type. Please speak to a sales executive for further information and specification details. Apartments have openable windows either side of mullions. Please speak to your sales agent for clarification.

BLOCK D

# Roof Plan

NORTH WEST

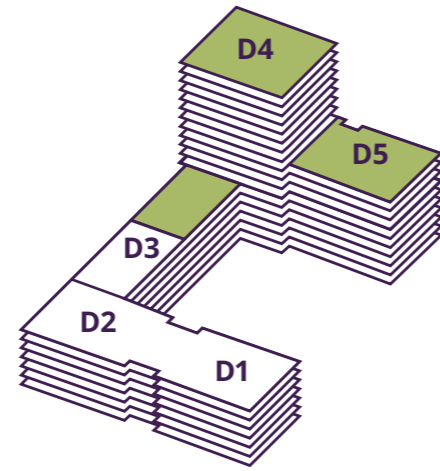

BLOCK D

# Roof Plan

NORTH EAST

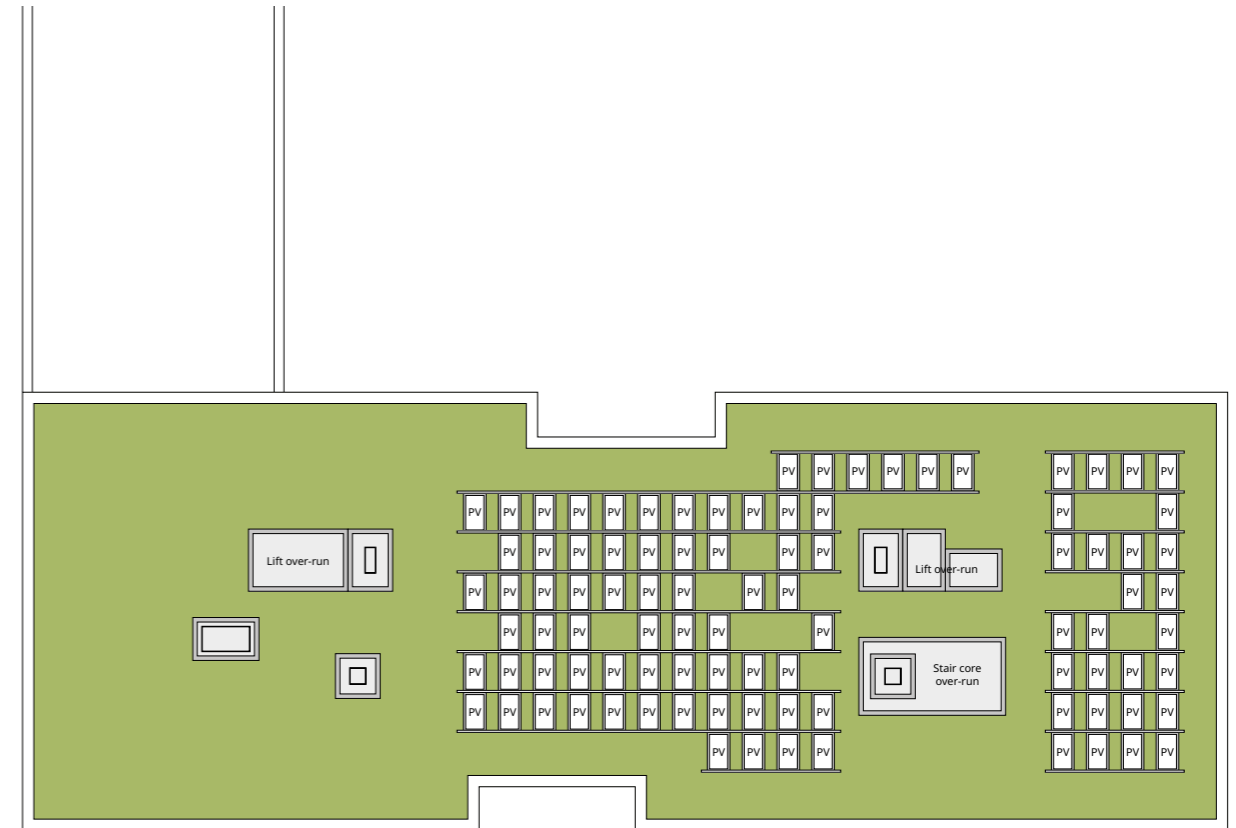
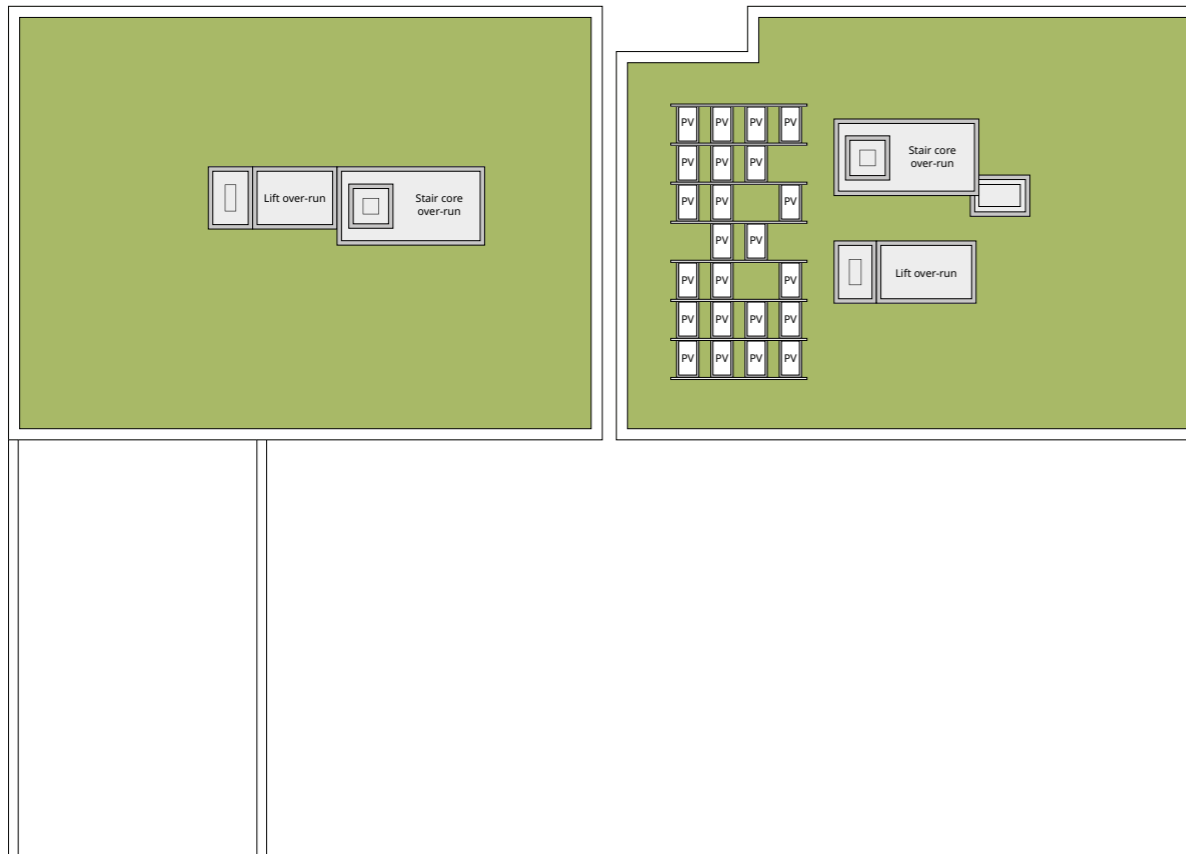
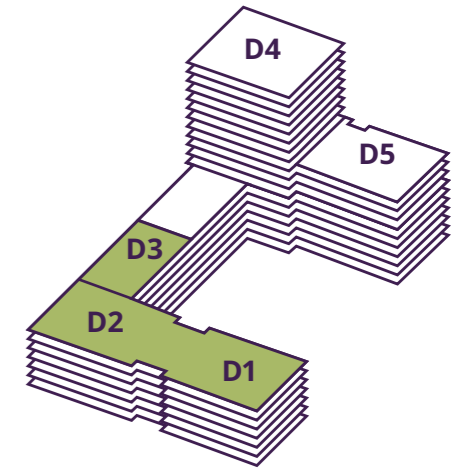

■ Roof  
PV Solar Panel

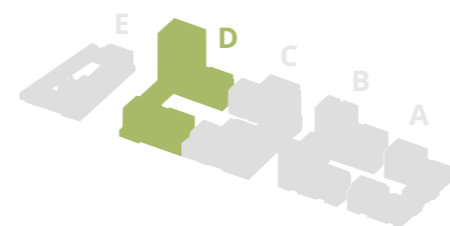

Floor plans depict a typical layout of this apartment type. For exact plot specification, details of external and internal finishes, dimensions and floor plan differences consult your sales executive. All dimensions are + or - 50mm and floor plans are not shown to scale. The kitchen layout and furniture positions are for indicative purposes only. Wheelchair accessible design is available for this property type and may have features which differ from our standard apartment type. Please speak to a sales executive for further information and specification details. Apartments have openable windows either side of mullions. Please speak to your sales agent for clarification.

# How to find us

## FROM A12 (EAST)

- Head south-west on A12
- Use the 2nd from the left lane to take the A106 exit towards Dalston/Hackney/Stratford/New Spitalfields Market/Westfield
- Turn right onto Eastway/A106 (signs for Clapton/Hackney/New Spitalfields Market)
- Turn right to stay on Eastway/A106
- Turn left onto Oliver Road, continue for 0.1 miles
- Coronation Square will be on your left

## FROM LEYTON TUBE STATION

- Walk north on High Road Leyton/A112 towards Maud Road
- Turn left onto Maud Road, after 384ft turn right onto York Road
- Continue onto Ruckholt Road/A106
- Turn right onto Oliver Road, after 0.1 miles
- Coronation Square will be on your left

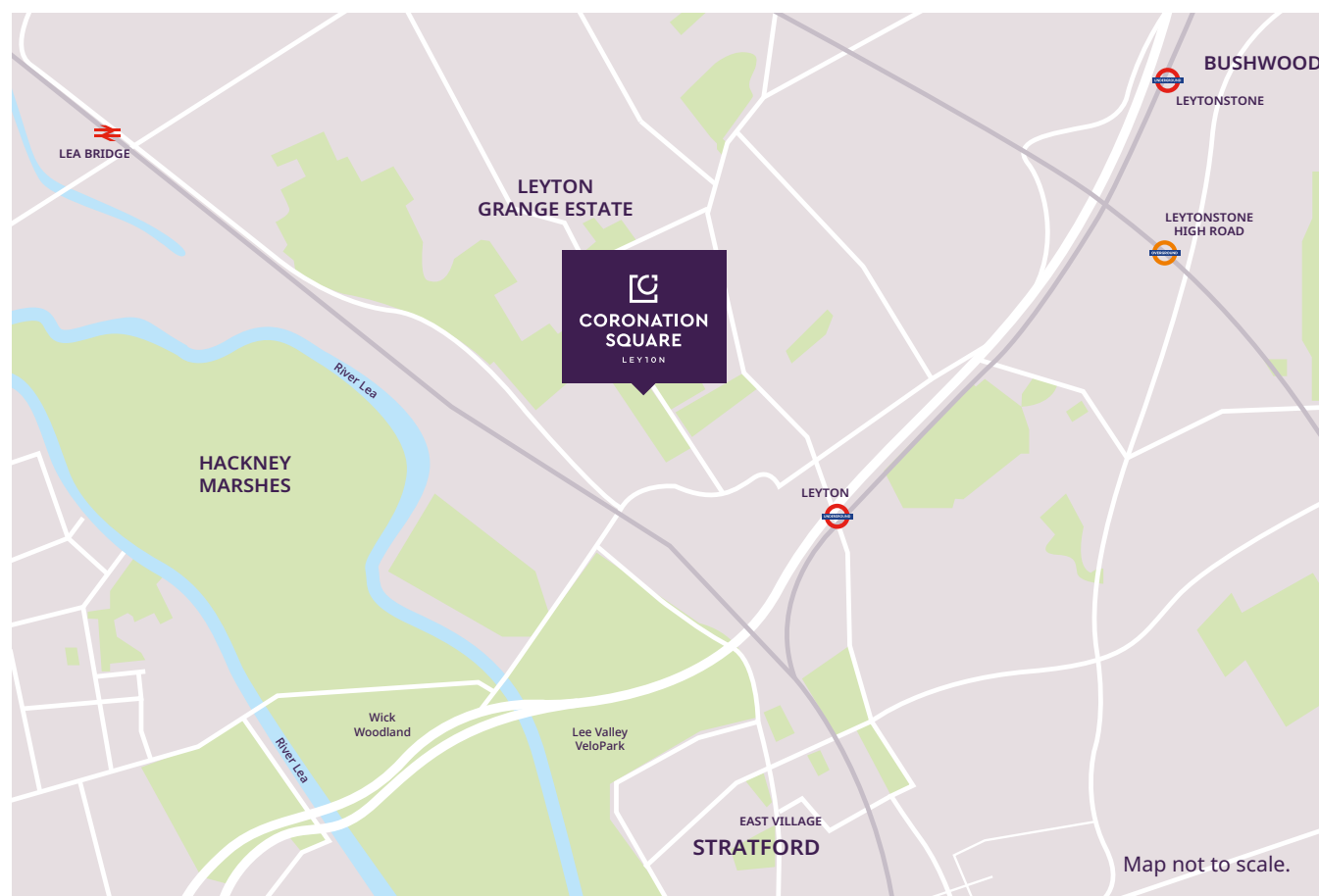

Taylor Wimpey reserves the right to change specifications, designs, Floor plans and siteplans at any time. All lifestyle and location imagery used within this brochure is indicative only. Please ask the sales executive for up-to-date information when reserving your new home. Information is correct at the time of broadcast. Please see the development page on our website for further details. Distances taken from google.co.uk/maps. 47890/January 2023.

## THE TAYLOR WIMPEY STORY

Taylor Wimpey have established an impressive track record for innovation and quality, with an unrivalled reputation for creating first-class residential developments – a reputation that we have built up over many years. We use this in-depth experience each time we plan, design and build a development, always considering the location and heritage that already exists in a town, county or region.

From our flagship city developments such as Postmark and Chobham Manor, to more unique refurbished-based projects such as Beaumont Gardens, our past and current developments offer homes that buyers can enjoy whilst experiencing all the benefits of a new-build home when it comes to energy efficiency and low maintenance. Whether you choose a village setting or the bustle of a market town, a country retreat or a city pad, you will find a home crafted for modern living.

At Taylor Wimpey we are proud of our business – and of the many awards we have won that recognise our commitment to delivering appealing new home schemes for the 21st century.



# MyPropTech

Nick Yan  
+852 9064 8554  
n.yan@myproptech.com

[www.myproptech.com](http://www.myproptech.com)